

Toggles

Rockers
B

Pushbuttons

Illuminated PB

Programmable

Keylocks

Rotaries

Slides

Tactiles

Tilt

Touch

Indicators

Accessories

Supplement



AS series..... B4
 Process Sealed
 0.4VA Logic Level
 Straight, Right Angle, & Vertical PC



CWS series..... B12
 6A Power Level
 Solder Lug, Quick Connect, & Right Angle PC
 Snap-in Mount



CWSB Series Illuminated..... B18
 Neon; 9A Power Level
 Quick Connect; Snap-in Mount



CWSC Series Illuminated..... B22
 LED; 9A Power Level
 Solder Lug/Quick Connect; Snap-in Mount



GS series..... B28
 Process Sealed
 0.4VA Logic Level
 Straight PC



GW Series..... B32
 Ultra-Thin
 0.4VA Logic Level
 Straight, Right Angle, & Vertical PC



GW Series Illuminated..... B36
 Fully Illuminated Paddle
 0.4VA Logic Level
 Straight, Right Angle, & Vertical PC



JW Series..... B40
 Internationally Approved
 10A & 16A Power Level
 Solder Lug; Snap-in-Mount



JWS Series Illuminated & Nonilluminated... B50
 Internationally Approved
 10A Power Level
 Solder Lug; Snap-in-Mount



LW Series Illuminated..... B56
 10A Power Level
 Incandescent Dual Lamps
 Solder Lug; Snap-in Mount



MS eries B62

Snap-in Mount
6A Power Level & 0.4VA Logic Level
Solder Lug, Quick Connect, Straight PC, & Wirewrap



MS eries B72

Bracketed PC Mount
6A Power Level & 0.4VA Logic Level
Straight, Right Angle, & Vertical PC with Bracket



MS eries B83

Flat Frame Mount
6A Power Level & 0.4VA Logic Level
Solder Lug & Straight PC



M2100 Series Illuminated B92

6A Power Level & 0.4VA Logic Level
Solder Lug, Quick Connect, & PC
Flat Frame & Snap-in Mount



M2T Series B98

Process Sealed
6A Power Level & 0.4VA Logic Level
Straight, Right Angle, & Vertical PC



MLW Series Illuminated B106

5A Power Level
Incandescent, Neon, & LED Lamps
Solder Lug; Snap-in Mount



P Series B114

Internationally Approved
10A Power Level
Solder Lug, Straight PC, & Quick Connect; Flat Frame Mount

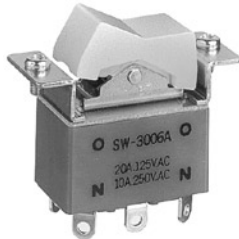

SW Series B120

15A to 30A Medium & High Capacity
Solder Lug & Screw Lug
Screw Mount



WR Series B124

Environmentally Sealed
15A Power Level
Solder Lug, Screw Lug, Wire Lead, & Quick Connect
Snap-in Mount

Rockers	Toggles
Rockers	Pushbuttons
Rockers	Illuminated PB
Rockers	Programmable
Rockers	Keylocks
Rockers	Rotaries
Rockers	Slides
Rockers	Tactiles
Rockers	Tilt
Rockers	Touch
Rockers	Indicators
Rockers	Accessories
Rockers	Supplement

General Specifications

Toggles

Rockers
B

Pushbuttons

Programmable
Illuminated PB

Keylocks

Rotaries

Slides

Tactiles

Tilt

Touch

Indicators

Accessories

Supplement

Electrical Capacity (Resistive Load)

Logic Level: 0.4VA maximum @ 28V AC/DC maximum
(Applicable Range 0.1mA ~ 0.1A @ 20mV ~ 28V)
Note: Find additional explanation of operating range in Supplement section.

Other Ratings

Contact Resistance: 50 milliohms maximum
Insulation Resistance: 500 megohms minimum @ 500V DC
Dielectric Strength: 500V AC minimum for 1 minute minimum
Mechanical Life: 100,000 operations minimum for On-None-On & On-Off-On
 50,000 operations minimum for other circuits
Electrical Life: 50,000 operations minimum
Nominal Operating Force: 2.73N (momentary); 1.84N (maintained)
Contact Timing: Nonshorting (break-before-make)
Angle of Throw: 26°

Materials & Finishes

Actuator or Toggle: Nickel plated brass
Case Housing: Glass fiber reinforced polyamide
Support Bracket: Tin plated phosphor bronze
Movable Contact: Phosphor bronze with gold plating
Stationary Contacts: Brass with gold plating
Terminals: Brass with gold plating

Environmental Data

Operating Temperature Range: -30°C through +85°C (-22°F through +185°F)
Humidity: 90 ~ 95% humidity for 240 hours @ 40°C (104°F)
Vibration: 10 ~ 55Hz with peak-to-peak amplitude of 1.5mm traversing the frequency range & returning in 1 minute; 3 right angled directions for 2 hours
Shock: 50G (490m/s²) acceleration (tested in 6 right angled directions, with 5 shocks in each direction)

Installation

Cap Installation Force: 39.23N (8.82 lbf) maximum downward force on actuator

PCB Processing

Soldering: Wave Soldering Recommended: See Profile A in Supplement section.
 Manual Soldering: See Profile B in Supplement section.
Cleaning: Automated cleaning. See Cleaning specifications in Supplement section.

Standards & Certifications

The A Series rockers have not been tested for UL recognition or CSA certification. These switches are designed for use in a low-voltage, low-current, logic-level circuit. When used as intended in a logic-level circuit, the results do not produce hazardous energy.

Distinctive Characteristics

Subminiature size saves space on PC boards.

Specifically developed for logic-level applications.

Totally sealed body construction prevents contact contamination and allows time- and money-saving automated soldering and cleaning.

Award-winning STC contact mechanism with benefits unavailable in conventional mechanisms: smoother, positive detent actuation, increased contact stability and unparalleled logic-level reliability. (Additional STC details in Terms & Acronyms; see Supplement section.)

Molded-in, epoxy sealed or ultrasonically welded terminals lock out flux, solvents, and other contaminants.

.100" x .100" (2.54mm x 2.54mm) terminal spacing conforms to standard PC board grid spacing.

Matching indicators available.

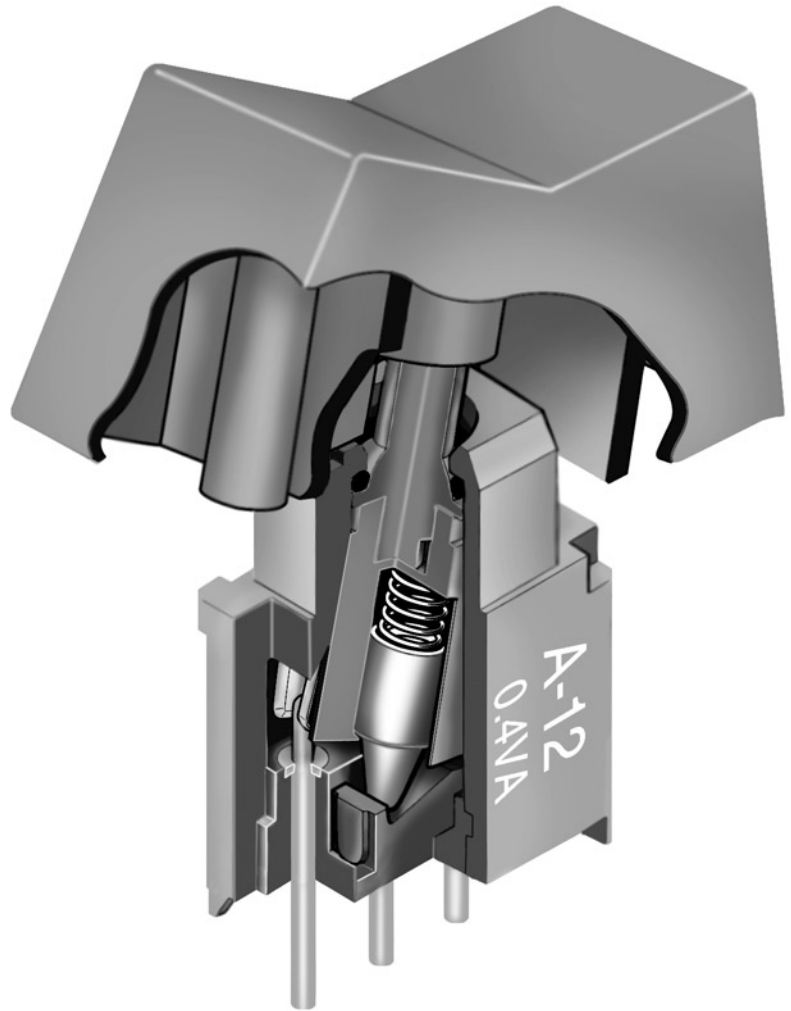

Actual Size

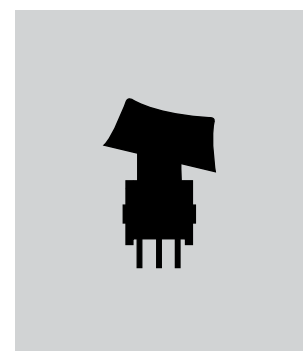

- Supplement
- Accessories
- Indicators
- Touch
- Tilt
- Tactiles
- Slides
- Rotaries
- Keylocks
- Programmable
- Illuminated PB
- Pushbuttons
- B** Rockers
- Toggles

TYPICAL SWITCH ORDERING EXAMPLE

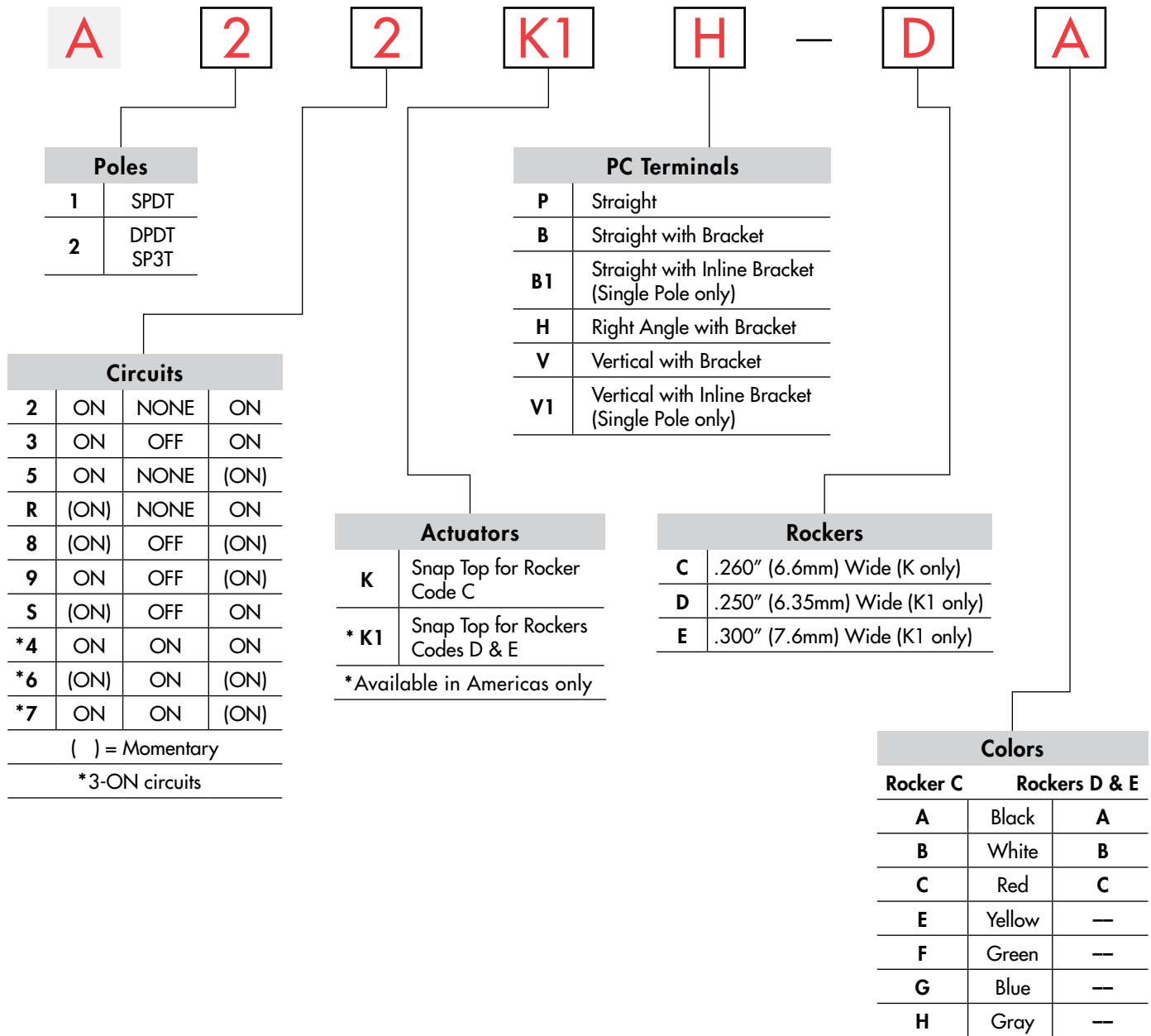

DESCRIPTION FOR TYPICAL ORDERING EXAMPLE

A22K1H-DA

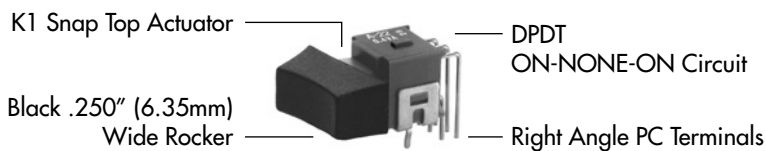

Toggles
Rockers
Pushbuttons
Illuminated PB
Programmable
Keylocks
Rotaries
Slides
Tactiles
Tilt
Touch
Indicators
Accessories
Supplement

POLES & CIRCUITS

Pole	Model	Rocker Position () = Momentary			Connected Terminals			Throw & Schematics
		Up	Center	Down	Up	Center	Down	
								Note: Terminal numbers are not actually on the switch.
SP	A12 A13 A15 A1R A18 A19 A1S	ON ON ON (ON) (ON) ON (ON)	NONE OFF NONE NONE OFF OFF OFF	ON ON (ON) ON (ON) (ON) ON	2-3	OPEN	2-1	SPDT
DP	A22 A23 A25 A2R A28 A29 A2S	ON ON ON (ON) (ON) ON (ON)	NONE OFF NONE NONE OFF OFF OFF	ON ON (ON) ON (ON) (ON) ON	2-3 5-6	OPEN	2-1 5-4	DPDT

For 3 Throw (3-On)

Connected Terminals & Schematics					External Connection
Pole	Model	Up	Center	Down	
SP	A24 A26 A27	ON (ON) ON 2-3 5-6	ON ON ON 2-3 5-4	ON (ON) (ON) 2-1 5-4	The SP3T model utilizes a double pole base. External connections must be made during field installation.

ACTUATORS



Snap Top

For Rocker AT469

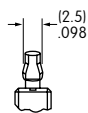
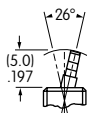

Snap Top

For Rockers AT062 and AT066

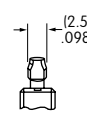
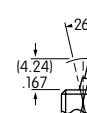

PC TERMINALS

Use of a support bracket is recommended to increase PCB mounting strength and stability.

P Straight

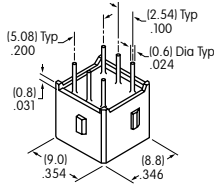

B Straight with Bracket

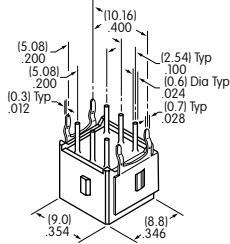

B1 Straight with Inline Bracket Single Pole only

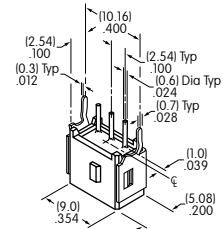

H Right Angle with Bracket

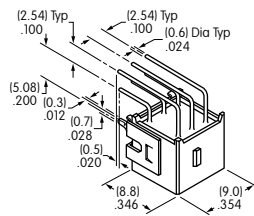

V Vertical with Bracket

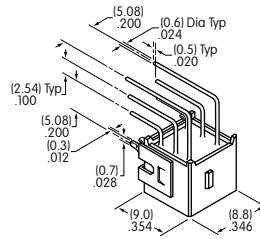

V1 Vertical with Inline Bracket Single Pole only

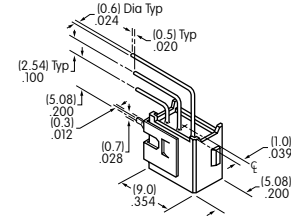

ROCKERS & COLORS

C AT469
.260" (6.6mm) Wide Rocker

Antirotational
Material: Polyamide
Colors Available:
A, B, C, E, F, G, H

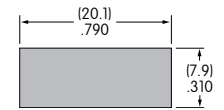
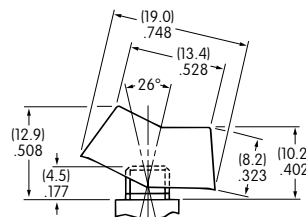
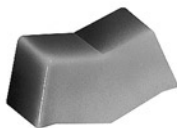

D AT062
.250" (6.35mm) Wide Rocker

Antirotational
Material: Polyamide
Colors Available:
A, B, C

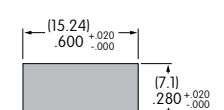
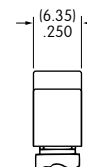
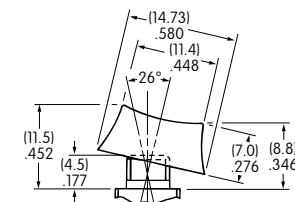
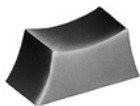

E AT066
.300" (7.6mm) Wide Rocker

Antirotational
Material: Polyamide
Colors Available:
A, B, C

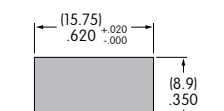
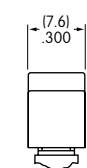
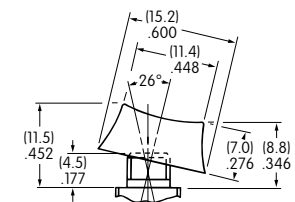
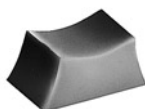

Color Codes:



Black



White



Red



Yellow



Green



Blue



Gray

TYPICAL SWITCH DIMENSIONS

Single Pole

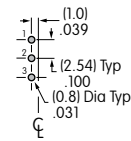
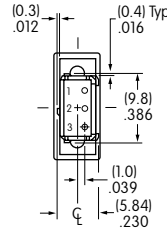
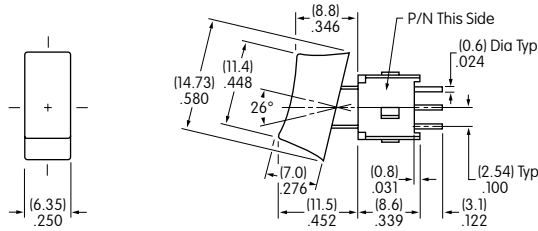

Straight PC



A12K1P-DA

Double Pole

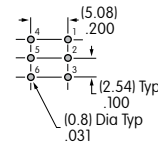
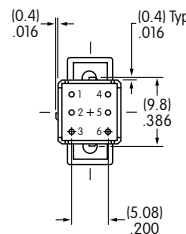
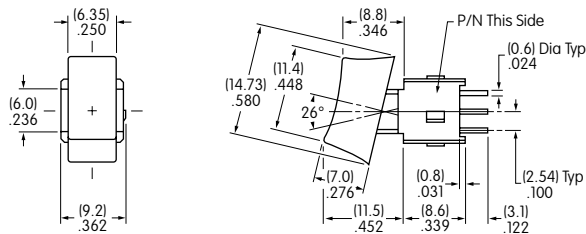

Straight PC



A22K1P-DA

Single Pole

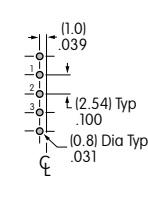
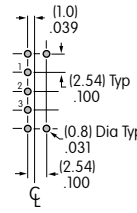
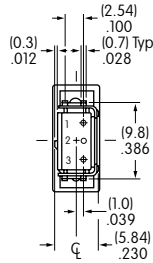
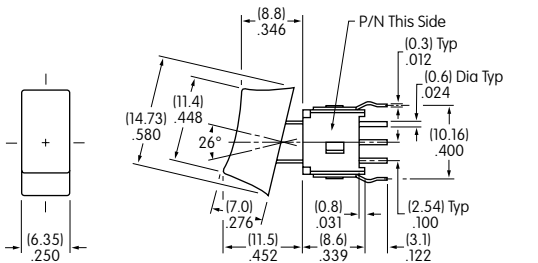

Straight PC • Bracket



A12K1B-DA

Double Pole

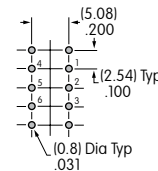
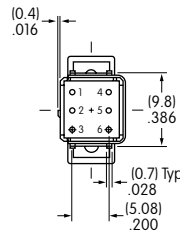
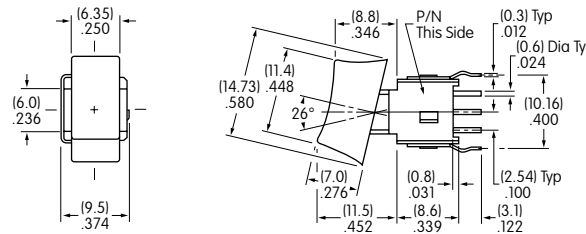

Straight PC • Bracket



A22K1B-DA

Single Pole

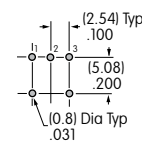
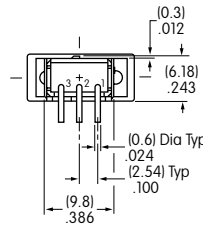
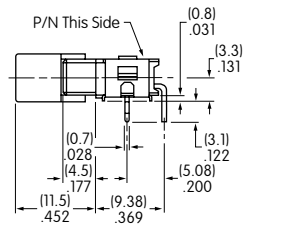
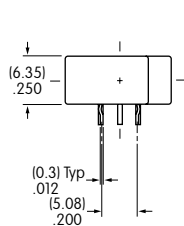

Right Angle PC



A12K1H-DA

TYPICAL SWITCH DIMENSIONS

Right Angle PC

Double Pole

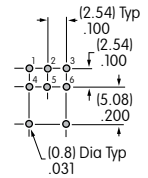
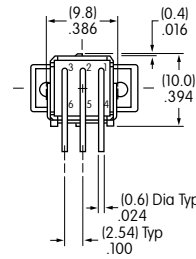
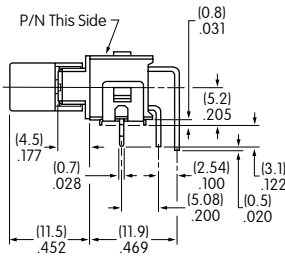
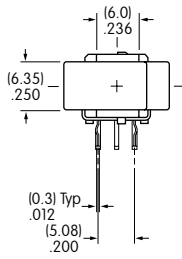

A22K1H-DA

Vertical PC

Single Pole

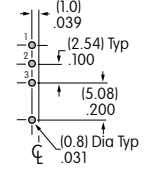
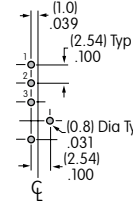
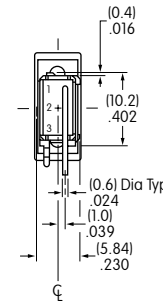
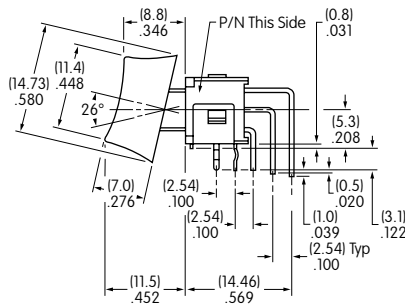
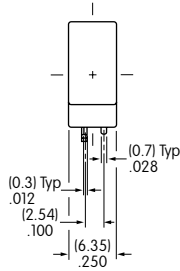

A12K1V-DA

V Terminals

V1 Terminals

Vertical PC

Double Pole

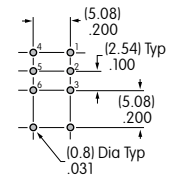
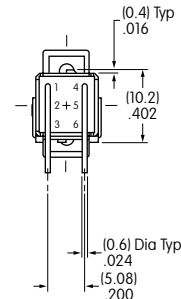
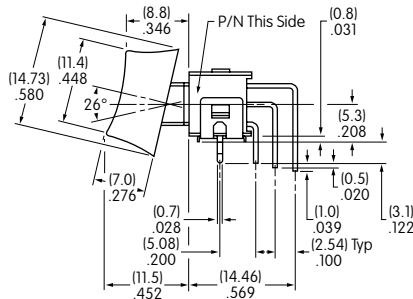
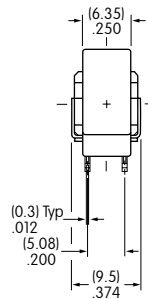

A22K1V-DA

ROCKER MOUNTING PRECAUTION

Rocker switches with vertical and right angle terminals must be mounted so that extension of the PC board beyond the top of the switch housing does not interrupt rocker movement, in turn causing incomplete switching operation.

The MAXIMUM limit of the PC board extension is .051" (1.3mm), as illustrated below.

This precaution does not apply to the double pole switch with right angle terminals due to the extra width of the switch allowing the rocker to clear the PC board.

Side View of Rocker Right Angle Mounting PC Single Pole Only

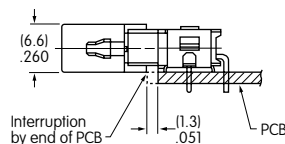

Side View of Rocker Vertical Mounting PC Single Pole and Double Pole

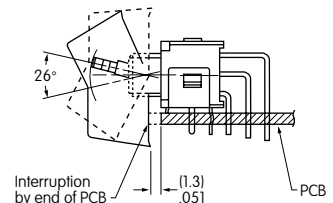

General Specifications

Toggles

Rockers

Pushbuttons

Illuminated PB

Programmable

Keylocks

Rotaries

Slides

Tactiles

Tilt

Touch

Indicators

Accessories

Supplement

B	CWSA	Electrical Capacity	Power Level: For Resistive Load 6A @ 250V AC
		Other Ratings	
		Contact Resistance:	20 milliohms maximum
		Insulation Resistance:	500 megohms minimum @ 500V DC
		Dielectric Strength:	1,500V AC minimum between contacts for 1 minute minimum 3,000V AC minimum between contacts & case for 1 minute minimum
		Mechanical Life:	30,000 operations minimum
		Electrical Life:	10,000 operations minimum with Resistive Load & 6,000 operations with Inductive Load
		Nominal Operating Force:	2.50N
		Angle of Throw:	30°
		Operating Temperature Range:	-10°C ~ +70°C (+14°F ~ +158°F)
	Materials & Finishes		
	Rocker:	Polycarbonate	Stationary Contacts: Silver alloy
	Housing:	Polyamide	Base: Laminated thermosetting sheets
	Movable Contactor:	Brass w/silver alloy plating	Contact Terminals: Copper with silver plating
	Movable Contacts:	Silver	Common Terminals: Brass with silver plating

	CWSB	Electrical Capacity	Power Level: For Resistive Load 6A @ 250V AC
		Other Ratings	
		Contact Resistance:	20 milliohms maximum
		Insulation Resistance:	500 megohms minimum @ 500V DC
		Dielectric Strength:	1,500V AC minimum between contacts for 1 minute minimum 3,000V AC minimum between contacts & case for 1 minute minimum
		Mechanical Life:	30,000 operations minimum
		Electrical Life:	10,000 operations minimum with Resistive Load & 6,000 operations with Inductive Load
		Nominal Operating Force:	6.50N for single pole models; 10.0N for double pole models
		Angle of Throw:	30°
		Operating Temperature Range:	-10°C ~ +70°C (+14°F ~ +158°F)
	Materials & Finishes		
	Rocker:	Polycarbonate	Stationary Contacts: Silver alloy
	Housing:	Polyamide	Base: Laminated thermosetting sheets
	Movable Contactor:	Beryllium copper w/silver alloy plating	Terminals: Brass with silver plating
	Movable Contacts:	Silver	

	CWT	Electrical Capacity	Power Level: For Resistive Load 6A @ 125V AC; 3A @ 250V AC; 4A @ 30V DC
		Other Ratings	
		Contact Resistance:	20 milliohms maximum
		Insulation Resistance:	1,000 megohms minimum @ 500V DC
		Dielectric Strength:	1,000V AC minimum between contacts for 1 minute minimum 1,500V AC minimum between contacts & case for 1 minute minimum
		Mechanical Life:	50,000 operations minimum
		Electrical Life:	25,000 operations minimum
		Nominal Operating Force:	2.0N
		Angle of Throw:	30°
		Operating Temperature Range:	-25°C ~ +70°C (-13°F ~ +158°F)
	Materials & Finishes		
	Rocker:	Glass fiber reinforced polyamide	Base: LCP (Liquid Crystal Polymer)
	Housing:	Polyamide	Contact Terminals: Brass + silver with silver plating
	Movable Contactor:	Phosphor bronze w/silver plating	Common Terminals: Brass with silver plating
	Movable Contacts:	Silver alloy	

Distinctive Characteristics

CWSA

- Low cost molded rocker.
- See-saw contact mechanism
- Stable stationary contact construction for high reliability.
- Easily installed with snap-in mounting.
- Large terminal hole dimensioned .067" x .098" (1.7mm x 2.5mm) simplifies wiring and soldering.
- Wave Soldering (PC version): See Profile A in Supplement section.
- Manual Soldering: See Profile A in Supplement section.



CWSB

- Low cost molded rocker.
- Snap-acting contact mechanism gives smooth actuation and audible feedback.
- Stable stationary contact construction for high reliability.
- Front panel, snap-in mounting for labor-saving installation.
- Solder lug/quick connect terminals can be used with connectors.
- Manual Soldering: See Profile B in Supplement section.



CWT

- Low cost molded rocker in compact, slim design.
- See-saw contact mechanism
- Outstanding insulation resistance and dielectric strength.
- Dust proof construction protects contact area.
- Stable stationary contact construction for high reliability.
- Front panel, snap-in mounting for labor-saving installation.
- Terminals are molded in and epoxy sealed to lock out flux, dust, and other contaminants.
- Manual Soldering: See Profile A in Supplement section.



- Toggle
- B** Rockers
- Pushbuttons
- Illuminated PB
- Programmable
- Keylocks
- Rotaries
- Slides
- Tactiles
- Tilt
- Touch
- Indicators
- Accessories
- Supplement

STANDARDS & CERTIFICATIONS

CWSA



Specific CWSA models listed below are qualified for Underwriters Laboratories Inc. recognition and Canadian Standards Association certification. cULus marking on case is standard as noted in following table.

<u>Model</u>	<u>Ratings @ AC</u>	<u>cULus File No.</u>	<u>Marking on Case</u>
CWSA11	6A @ 250V	E44145	Standard
CWSA12	6A @ 250V	E44145	Standard

CWSB



Specific CWSB models listed below are qualified for Underwriters Laboratories Inc. recognition and Canadian Standards Association certification. cULus marking on case is standard as noted in following table.

<u>Model</u>	<u>Ratings @ AC</u>	<u>cULus File No.</u>	<u>Marking on Case</u>
CWSB11	6A @ 250V	E44145	Standard
CWSB21	6A @ 250V	E44145	Standard

CWT



Specific CWT model listed below is qualified for Underwriters Laboratories Inc. recognition and Canadian Standards Association certification. cULus marking on case is standard as noted in following table.

<u>Model</u>	<u>Ratings @ AC</u>	<u>cULus File No.</u>	<u>Marking on Case</u>
CWT12	6A @ 125V 3A @ 250V	E44145	Standard

Toggles

Rockers **B**

Pushbuttons

Illuminated PB

Programmable

Keylocks

Rotaries

Slides

Tactiles

Tilt

Touch

Indicators

Accessories

Supplement

TYPICAL SWITCH ORDERING EXAMPLES

CWSA **1** **1** **A** **A** **N** **S**

Pole	
1	SPST & SPDT

Circuits			
1	ON	NONE	OFF
2	ON	NONE	ON

Cap Color	
A	Black

Housing	
A	Black

Inscription	
For SPST & SPDT	
No Code	None
For SPST	
1	Horizontal
2	Vertical
3	Dot Marking

Terminals	
S	Solder Lug*
H	Right Angle PC

TYPICAL ORDERING EXAMPLE
CWSA11AANS



* Wire harness & cable assemblies offered only in Americas

CWSB **2** **1** **A** **A** **2** **F**

Poles	
1	SPST
2	DPST

Circuit			
1	ON	NONE	OFF

Cap Color	
A	Black

Housing	
A	Black

Inscription	
No Code	None (SPST only)
1	Horizontal
2	Vertical
3	Dot Marking (SPST only)

Terminals	
F	Quick Connect*
H	Right Angle PC

TYPICAL ORDERING EXAMPLE
CWSB21AA2F



* Wire harness & cable assemblies offered only in Americas

CWT **1** **2** **A** **A** **S1**

Pole	
1	SPDT

Circuit			
2	ON	NONE	ON

Cap Color	
A	Black

Housing	
A	Black

Terminals	
S1	Solder Lug*

TYPICAL ORDERING EXAMPLE
CWT12AAS1



* Wire harness & cable assemblies offered only in Americas

INSCRIPTIONS

No Code

None

Not available in double pole.

1

Horizontal Orientation

Only On-None-Off models are available with the horizontal inscription.

2

Vertical Orientation

Only On-None-Off models are available with the vertical inscription.

3

Dot Marking

Only Single Pole On-None-Off models are available with the dot inscription.

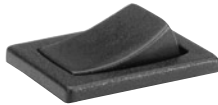

The IEC symbols for On-Off are supplied with Single Throw models only. Orientation of inscription must be selected. Inscription color is white ink on black.

TYPICAL SWITCH DIMENSIONS FOR CWSA

Solder Lug

Single Pole • No Inscription

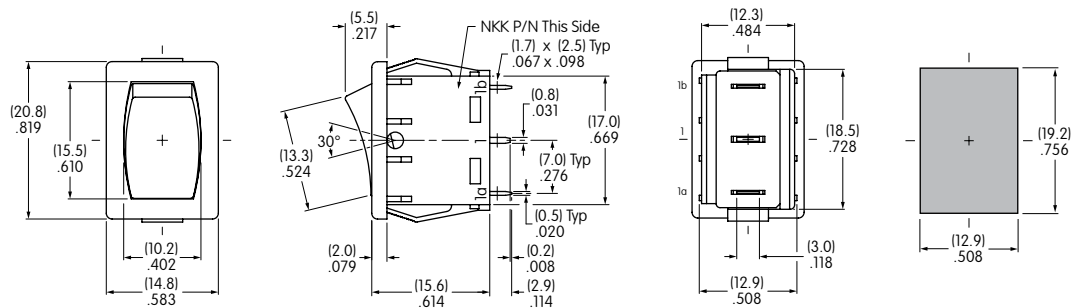

Terminal numbers are on side of switch body

Panel Thickness .030" ~ .079" (0.75mm ~ 2.0mm)

CWSA12AANS

Right Angle

Single Pole • Horizontal On-Off Inscription

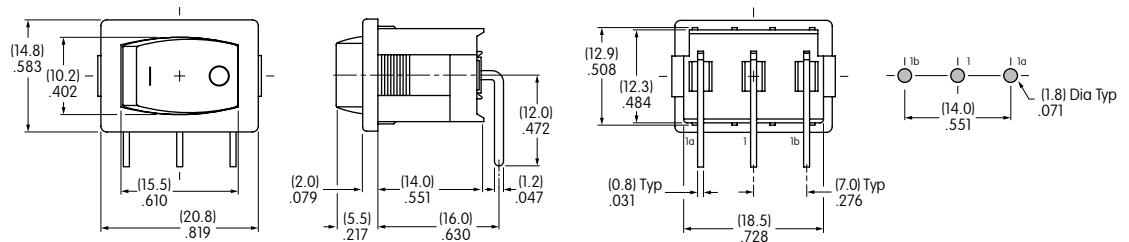

Single throw model does not have terminal 1b

Terminal numbers are on side of switch body

CWSA11AAN1H

TYPICAL SWITCH DIMENSIONS FOR CWSB

Double Pole • Vertical On-Off Inscription

Quick Connect

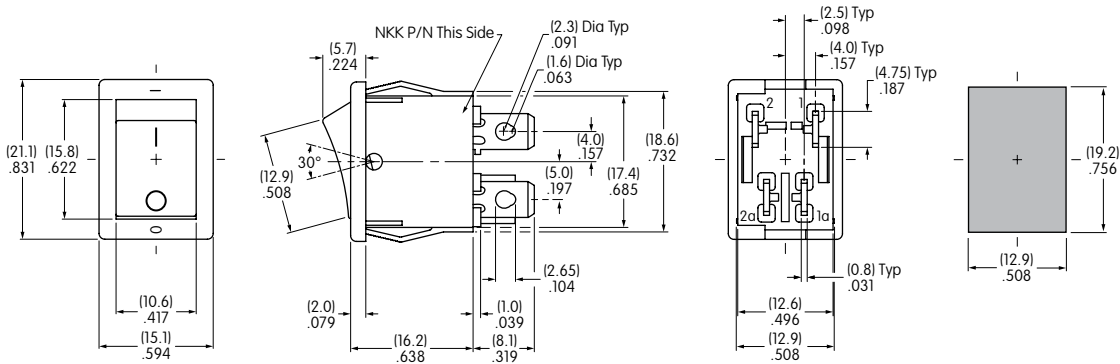

Terminal numbers are on bottom of switch

Panel Thickness
.030" ~ .079"
(0.75mm ~ 2.0mm)

CWSB21AA2F



Single Pole • Dot Inscription

Right Angle

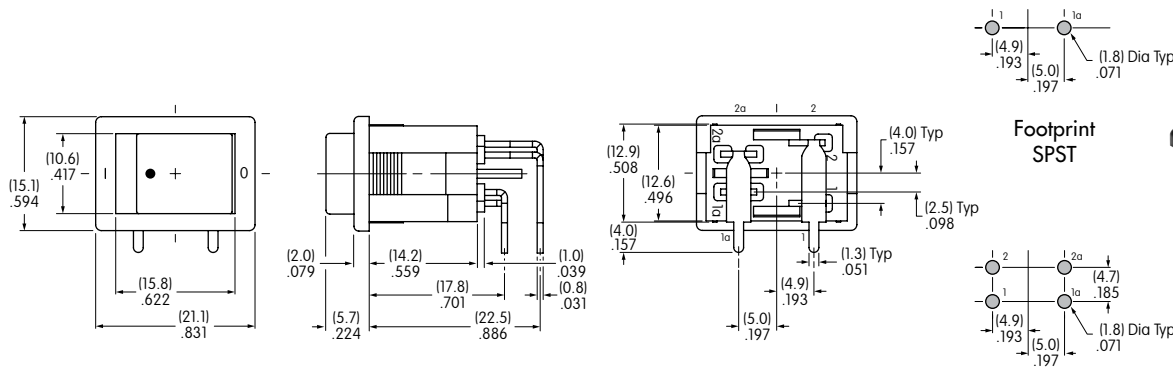

Terminal numbers are on bottom of switch

Footprint DPST

CWSB11AA3H



TYPICAL SWITCH DIMENSIONS FOR CWT

Single Pole • No Inscription

Solder Lug

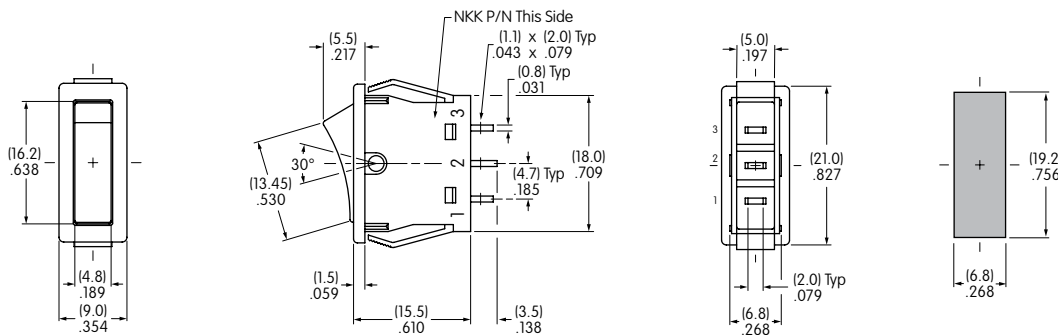

Terminal numbers are on side of switch body

Panel Thickness
.030" ~ .079"
(0.75mm ~ 2.0mm)

CWT12AAS1



General Specifications

Toggle

Rockers
B

Pushbuttons

Illuminated PB

Programmable

Keylocks

Rotaries

Slides

Tactiles

Tilt

Touch

Indicators

Accessories

Supplement

Electrical Capacity (Resistive Load)

Power Level: 9A @ 125V AC

Other Ratings

Contact Resistance: 20 milliohms maximum

Insulation Resistance: 500 megohms minimum @ 500V DC

Dielectric Strength: 1,500V AC minimum between contacts for 1 minute minimum;
3,000V AC minimum between contacts & case for 1 minute minimum

Mechanical Life: 30,000 operations minimum

Electrical Life: 10,000 operations minimum

Nominal Operating Force: 10.0N

Angle of Throw: 30°

Materials & Finishes

Rocker: Polycarbonate

Housing: Polyamide

Movable Contactor: Beryllium copper with silver plating

Movable Contacts: Silver alloy

Stationary Contacts: Silver alloy

Switch Terminals: Brass with silver plating

Lamp Terminals: Brass with silver plating

Environmental Data

Operating Temp Range: -20°C through +85°C (-4°F through +185°F)

Humidity: 90 ~ 95% humidity for 96 hours @ 40°C (104°F)

Vibration: 10 ~ 55Hz with peak-to-peak amplitude of 0.75mm traversing the frequency range & returning in 1 minute; 3 right angled directions for 2 hours

Shock: 50G (490m/s²) acceleration (tested in 6 right angled directions, with 5 shocks in each direction)

Installation

Soldering Time & Temp: Manual Soldering: See Profile B in Supplement section.

Standards & Certifications

UL: File No. E44145
9A @ 125V AC
Markings on case are standard.

CSA: File No. 0701166_0_000
9A @ 125V AC
Markings on case are standard.

Distinctive Characteristics

Full face, Neon illumination in choice of red, amber, or green.

Neon lamp suited to 125V AC applications.

9-amp electrical capacity in compact body.

Built-in resistor for direct connection to 125V AC power source.

Low cost molded rocker.

Front panel, snap-in mounting assures labor-saving installation.

Single-break, snap-acting contact mechanism gives smooth actuation and audible feedback.

Quick-make, quick-break characteristic limits arcing and prolongs electrical life.

Stable stationary contact construction for high reliability.

Offset terminal alignment gives outstanding insulation resistance and dielectric strength.

Solder lug/.187" quick connect terminals can be used with connectors.

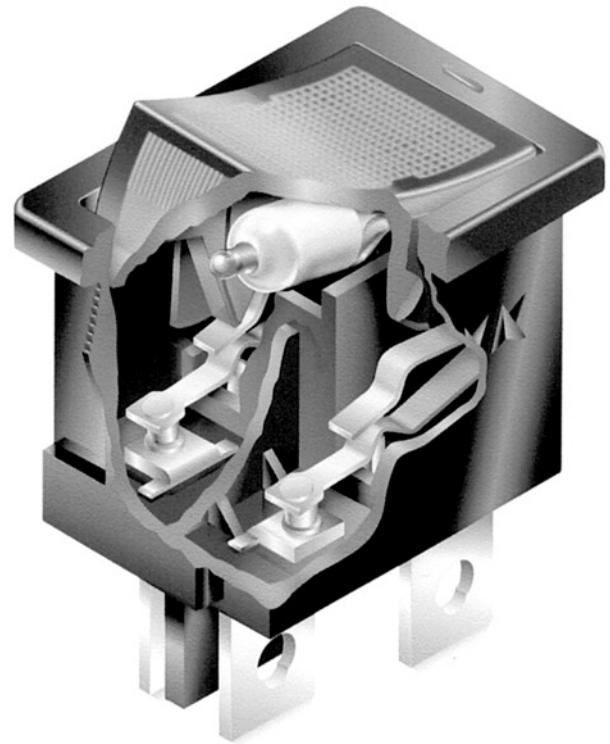

Actual Size

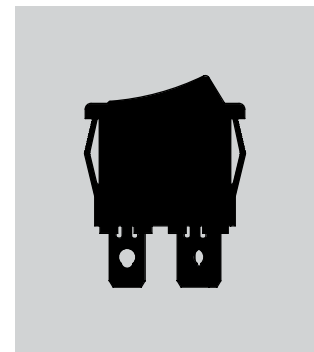

Toggles
Rockers
Pushbuttons
Illuminated PB
Programmable
Keylocks
Rotaries
Slides
Tactiles
Tilt
Touch
Indicators
Accessories
Supplement

TYPICAL SWITCH ORDERING EXAMPLE

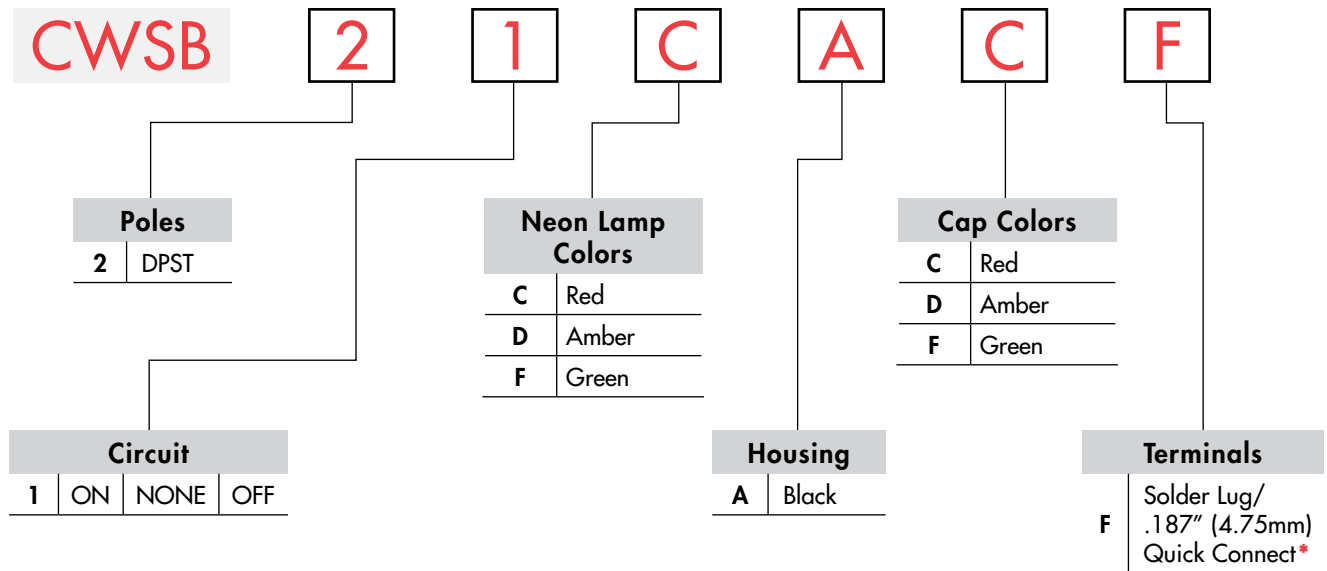

* Wire harness & cable assemblies offered only in Americas

DESCRIPTION FOR TYPICAL ORDERING EXAMPLE

CWSB21CACF

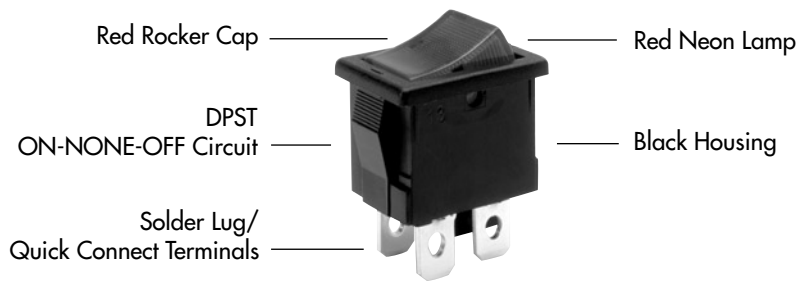

IMPORTANT:



Switches are supplied with UL & CSA markings on case. Specific models & ratings noted on General Specifications page.

POLE & CIRCUIT

Pole	Model	Rocker Position			Connected Terminals			Throw & Switch/Lamp Schematic
		Down	Center	Up	Down	Center	Up	
DP	CWSB21	ON	NONE	OFF	1-1a 2-2a	OPEN	OPEN	DPST

Note: Terminal numbers "1a" & "2a" are actually on the switch.

NEON LAMP COLORS & SPECIFICATIONS

The Neon lamp is factory assembled and not available separately. The lamp circuit is synchronous to switching circuit.

The electrical specifications shown are determined at a basic temperature of 25°C.

Values for the built-in resistors are given in the accompanying table.

		Colors		
		C Red	D Amber	F Green
Voltage	V	125V AC	125V AC	125V AC
Internal Series Resistance		33K ohms	33K ohms	68K ohms
Current	I	1.4mA	1.4mA	0.6mA
Endurance	Hours	15,000	15,000	8,000

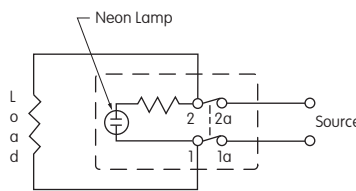

HOUSING

A Black Housing with Snap-in Mounting

On Off (I O) symbols are molded on the bezel.



TERMINALS

F Solder Lug/.187" (4.75mm) Quick Connect

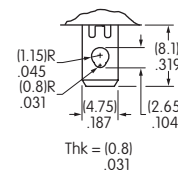

CAP COLOR CODES

Cap Colors Available

C Red **D** Amber **F** Green

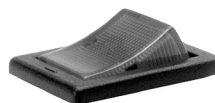

Caps are factory assembled and are not available separately.

TYPICAL SWITCH DIMENSIONS

Double Pole

Neon Illuminated

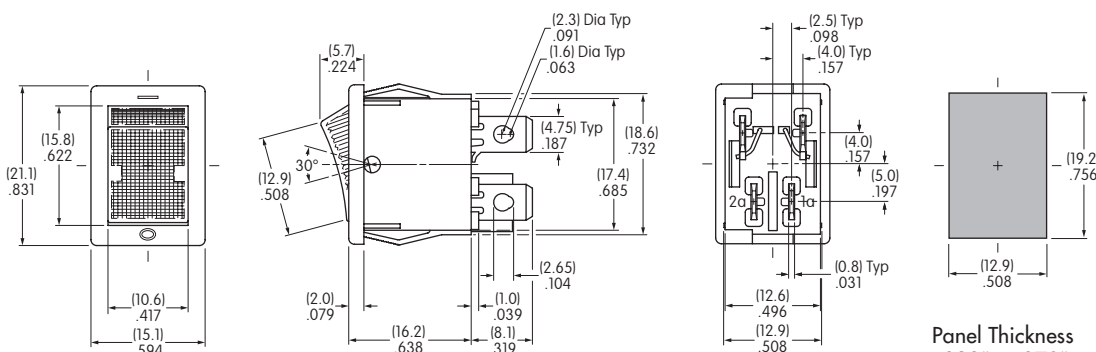

Panel Thickness
.030" ~ .079"
(0.75mm ~ 2.0mm)



CWSB21CACF

Toggles
Rockers
Pushbuttons
Illuminated PB
Programmable
Keylocks
Rotaries
Slides
Tactiles
Tilt
Touch
Indicators
Accessories
Supplement

General Specifications

Toggles

Rockers
B

Pushbuttons

Illuminated PB

Programmable

Keylocks

Rotaries

Slides

Tactiles

Tilt

Touch

Indicators

Accessories

Supplement

Electrical Capacity (Resistive Load)

Power Level: 9A @ 125V AC or 6A @ 250V AC

Other Ratings

Contact Resistance: 20 milliohms maximum

Insulation Resistance: 500 megohms minimum @ 500V DC

Dielectric Strength: 1,500V AC minimum between contacts for 1 minute minimum;
3,000V AC minimum between contacts & case for 1 minute minimum

Mechanical Life: 30,000 operations minimum

Electrical Life: 10,000 operations minimum

Nominal Operating Force: Single Pole 4.50N; Double Pole 10.0N

Angle of Throw: 33°

Materials & Finishes

Rocker: Polycarbonate

Housing: Polyamide

Movable Contactor: Beryllium copper with silver plating

Movable Contacts: Silver alloy

Stationary Contacts: Silver alloy

Switch Terminals: Brass with silver plating

Lamp Terminals: Brass with silver plating

Environmental Data

Operating Temp Range: -10°C through +50°C (+14°F through +122°F)

Humidity: 90 ~ 95% humidity for 96 hours @ 40°C (104°F)

Vibration: 10 ~ 55Hz with peak-to-peak amplitude of 1.5mm traversing the frequency range & returning in 1 minute; 3 right angled directions for 2 hours

Shock: 50G (490m/s²) acceleration (tested in 6 right angled directions, with 5 shocks in each direction)

Installation

Soldering Time & Temp: Manual Soldering: See Profile A in Supplement section.

Standards & Certifications

UL: File No. E44145

All models recognized at 9A @ 125V AC & 6A @ 250V AC.
cULus marking on case is standard.

Distinctive Characteristics

Full face, bright LED illumination in choice of red, amber, or green for visible status indication.

9-amp or 6-amp electrical capacity in compact body.

Interior shield prevents contamination of the rocker by carbon from arcing.

Front panel, snap-in mounting assures labor-saving installation.

Single-break, snap-acting contact mechanism gives smooth actuation and audible feedback.

Quick-make, quick-break characteristic limits arcing and prolongs electrical life.

Stable stationary contact construction for high reliability.

Offset terminal alignment gives outstanding insulation resistance and dielectric strength.

Solder lug/.110" quick connect terminals can be used with connectors.



Actual Size

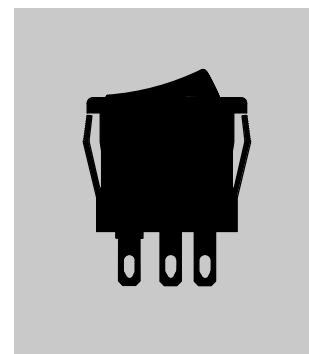

TYPICAL SWITCH ORDERING EXAMPLE

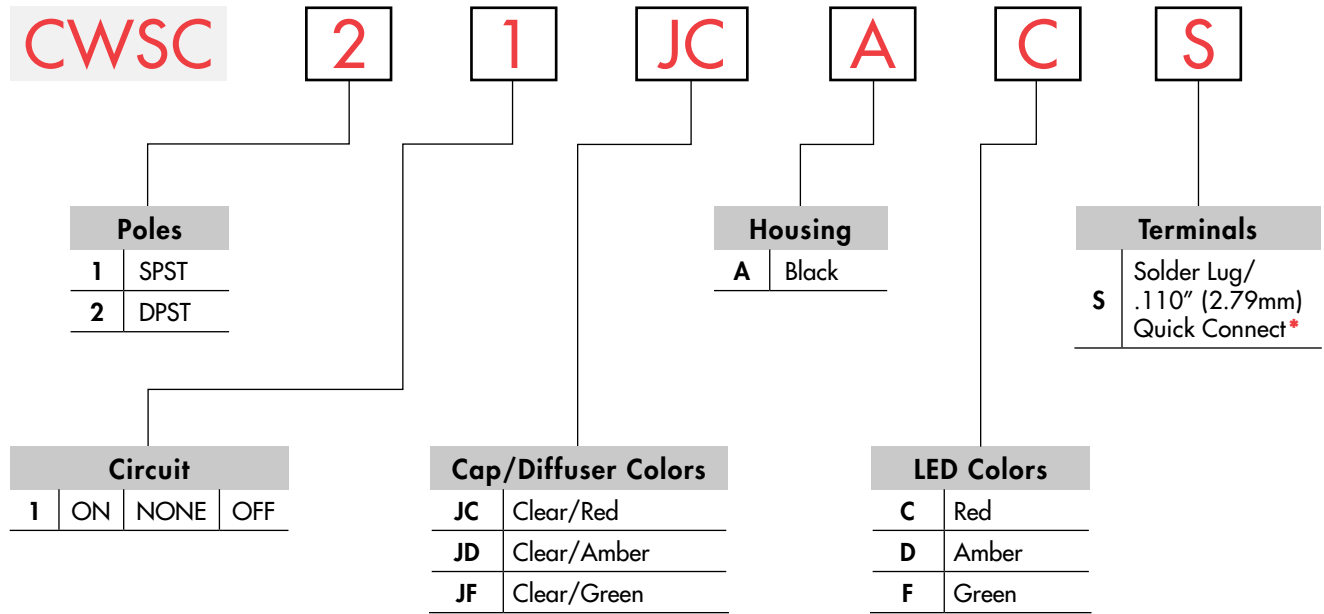

* Wire harness & cable assemblies offered only in Americas

TYPICAL ORDERING EXAMPLE

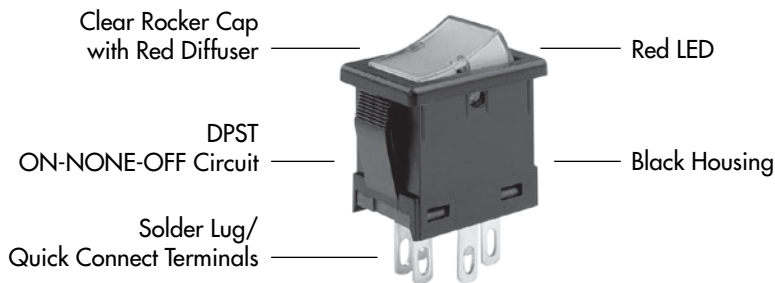

CWSC21JCACS



IMPORTANT:

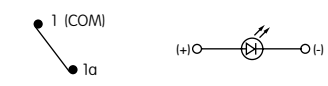

Switches are supplied with cULus marking on case. Specific models & ratings noted on General Specifications page.

POLE & CIRCUITS									
		Rocker Position			Connected Terminals			Throw & Switch/Lamp Schematics	
Pole	Model	Down	Center	Up	Down	Center	Up	Notes: Terminal numbers and polarity are actually on the switch.	
SP	CWSC11	ON	NONE	OFF	1-1a	OPEN	OPEN		SPST 
DP	CWSC21	ON	NONE	OFF	1-1a 2-2a	OPEN	OPEN		DPST 

CAP TYPES & COLORS

Rocker Cap/Diffuser

Caps are factory assembled and are not available separately.



Cap/Diffuser Colors Available

- JC** Clear/Red
- JD** Clear/Amber
- JF** Clear/Green

HOUSING

- A** Black Housing with Snap-in Mounting

On Off (I O) symbols are molded on the bezel.



TERMINALS

- S** Solder Lug/.110" (2.79mm) Quick Connect

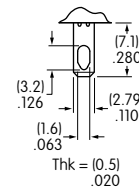

LED SPECIFICATIONS & COLORS

The LED is factory assembled and not available separately. LED circuit is isolated and requires an external power source. Polarity marks are on the bottom of the switch.

The electrical specifications shown are determined at a basic temperature of 25°C.

If the source voltage exceeds the rated voltage, a ballast resistor is required. The resistor value can be calculated by using the formula in the Supplement.

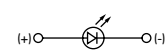
		C	D	F	
		Red	Amber	Green	
	Colors:	Red	Amber	Green	
	Forward Peak Current	I_{FM}	30mA	30mA	30mA
	Typical Forward Current	I_F	20mA	20mA	20mA
	Forward Voltage	V_F	1.95V	2.0V	2.1V
	Reverse Peak Voltage	V_{RM}	5V	5V	5V
	Current Reduction Rate above 25°C	ΔI_F	0.41mA/°C	0.29mA/°C	0.39mA/°C
Ambient Temperature Range		-10°C ~ +50°C			

Toggles
 Rockers
 Pushbuttons
 Illuminated PB
 Programmable
 Keylocks
 Rotaries
 Slides
 Tactiles
 Tilt
 Touch
 Indicators
 Accessories
 Supplement

TYPICAL SWITCH DIMENSIONS

LED Illuminated

Single Pole

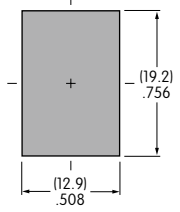
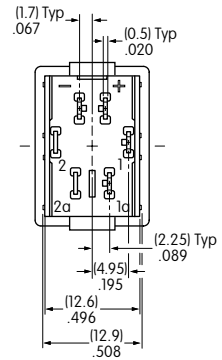
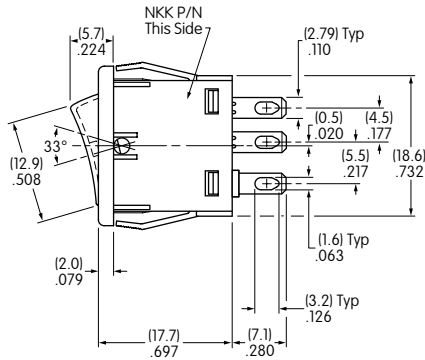
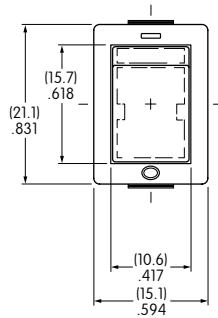

CWSC11JCACS

Panel Thickness
.030" ~ .079"
(0.75mm ~ 2.0mm)

LED Illuminated

Double Pole

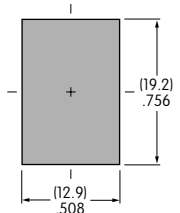
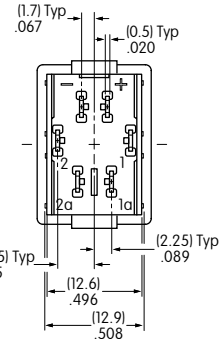
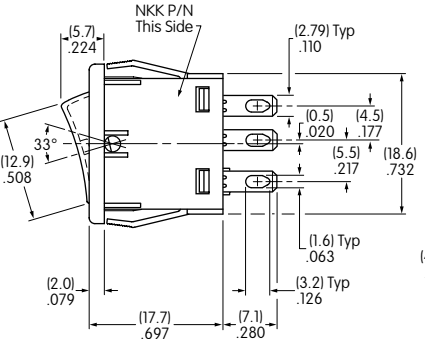
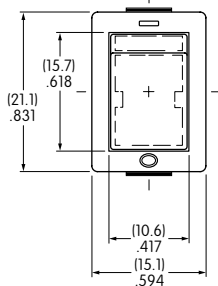

CWSC21JCACS

Panel Thickness
.030" ~ .079"
(0.75mm ~ 2.0mm)

Toggle

Rockers
B

Pushbuttons

Illuminated PB

Programmable

Keylocks

Rotaries

Slides

Tactiles

Tilt

Touch

Indicators

Accessories

Supplement

General Specifications

Toggles

Rockers
B

Pushbuttons

Illuminated PB

Programmable

Keylocks

Rotaries

Slides

Tactiles

Tilt

Touch

Indicators

Accessories

Supplement

Electrical Capacity (Resistive Load)

Logic Level: 0.4VA maximum @ 28V AC/DC maximum
(Applicable Range 0.1mA ~ 0.1A @ 20mV ~ 28V)
Note: Find additional explanation of operating range in Supplement section.

Other Ratings

Contact Resistance: 80 milliohms maximum
Insulation Resistance: 500 megohms minimum @ 500V DC
Dielectric Strength: 500V AC minimum for 1 minute minimum
Mechanical Life: 100,000 operations minimum for On-None-On & On-Off-On
 50,000 operations minimum for other circuits
Electrical Life: 100,000 operations minimum for On-None-On & On-Off-On
 50,000 operations minimum for other circuits
Nominal Operating Force: .81N for momentary & 1.06N for maintained
Angle of Throw: 28°

Materials & Finishes

Actuator: Glass fiber reinforced polyamide
Case: Glass fiber reinforced polyamide
Sealing Rings: Nitrile butadiene rubber
Movable Contact: Phosphor bronze with gold plating
Stationary Contacts: Phosphor bronze with gold plating
Base: Glass fiber reinforced polyamide
Terminals: Phosphor bronze with gold plating

Environmental Data

Operating Temperature Range: -25°C through +85°C (-13°F through +185°F)
Humidity: 90 ~ 95% humidity for 96 hours @ 40°C (104°F)
Vibration: 10 ~ 55Hz with peak-to-peak amplitude of 1.5mm traversing the frequency range & returning in 1 minute; 3 right angled directions for 2 hours
Shock: 50G (490m/s²) acceleration (tested in 6 right angled directions, with 5 shocks in each direction)

Installation

Cap Installation Force: 39.1N (8.8 lbf) maximum downward force on actuator

PCB Processing

Soldering: Wave Soldering Recommended: See Profile A in Supplement section.
 Manual Soldering: See Profile A in Supplement section.
Cleaning: Automated cleaning. See Cleaning specifications in Supplement section.

Standards & Certifications

The G Series rockers have not been tested for UL recognition or CSA certification. These switches are designed for use in a low-voltage, low-current, logic-level circuit. When used as intended in a logic-level circuit, the results do not produce hazardous energy.

Distinctive Characteristics

Ultra-miniature size allows high density mounting, and extremely light weight of 0.25 gram makes these switches ideal for handheld equipment.

Totally sealed body construction prevents contact contamination and allows time-and money-saving automated soldering and cleaning.

Award-winning STC contact mechanism with benefits unavailable in conventional mechanisms: smoother, positive detent actuation, increased contact stability and unparalleled logic-level reliability. (Additional STC details in Terms & Acronyms; see Supplement section.)

.100" x .100" (2.54mm x 2.54mm) terminal spacing conforms to standard PC board grid spacing. Round terminals facilitate easier through-hole mounting on PC boards.

Matching indicators available.

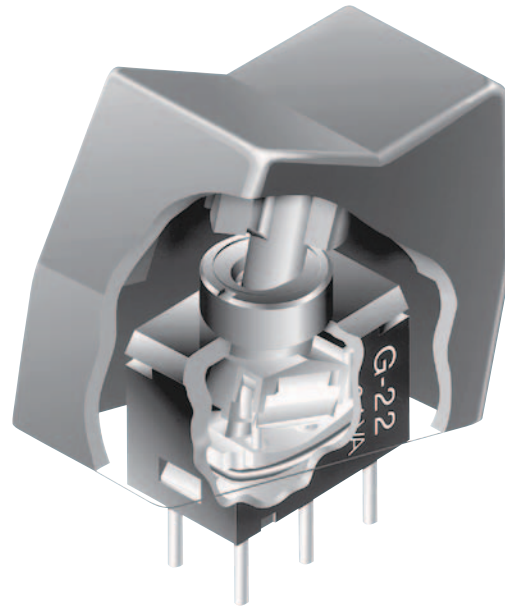

Actual Size

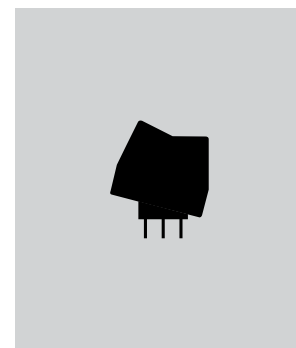

Supplement

- Accessories
- Indicators
- Touch
- Tilt
- Tactiles
- Slides
- Rotaries
- Keylocks
- Programmable
- Illuminated PB
- Pushbuttons
- B** Rockers
- Toggle

TYPICAL SWITCH ORDERING EXAMPLE

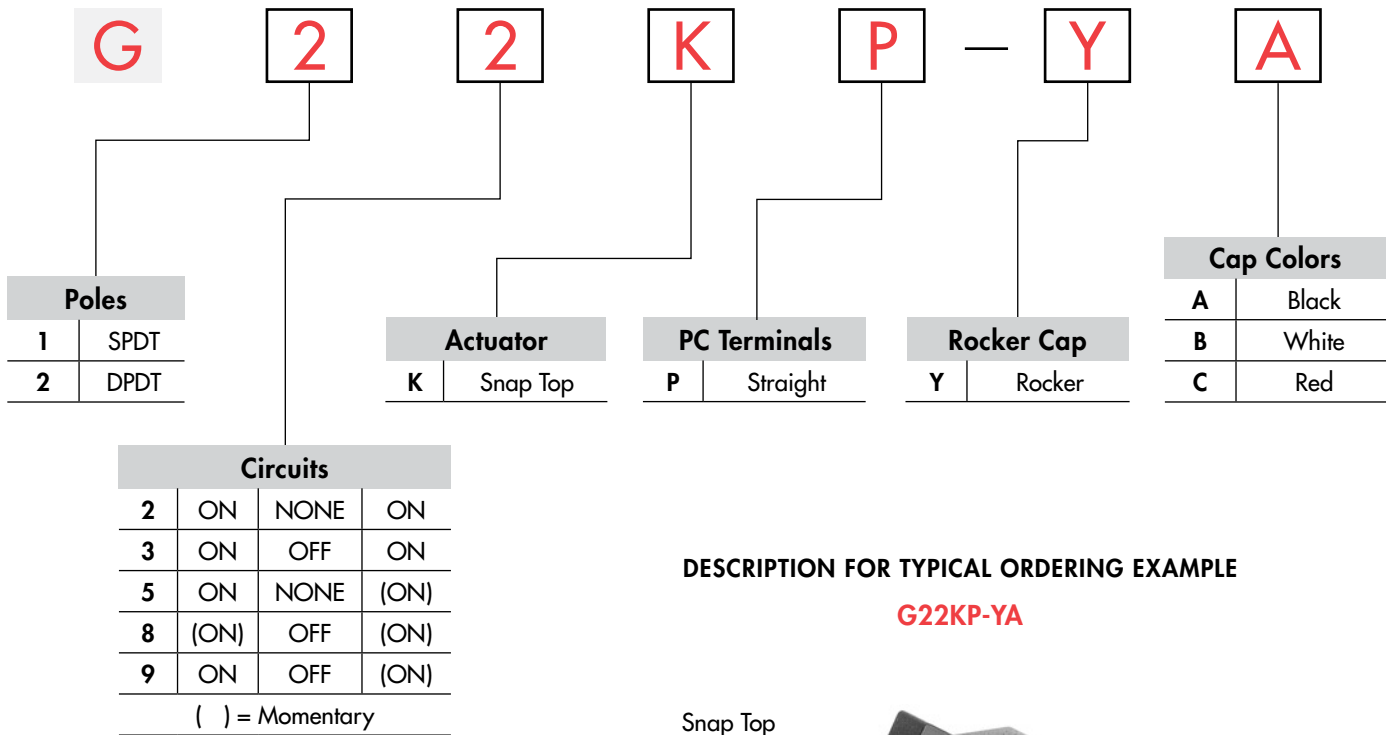

DESCRIPTION FOR TYPICAL ORDERING EXAMPLE

G22KP-YA

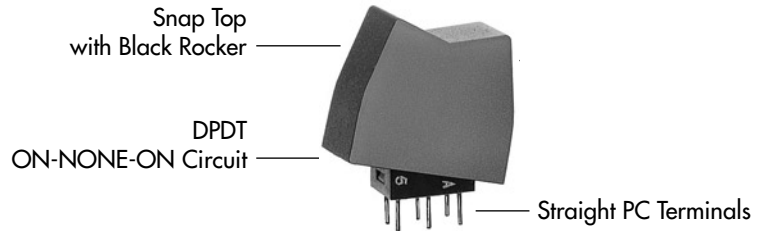

POLES & CIRCUITS

Pole	Model	Rocker Position () = Momentary			Connected Terminals			Throw & Schematics
		Up	Center	Down	Up	Center	Down	
SP	G12 G13 G15 G18 G19	ON ON ON (ON) ON	NONE OFF NONE OFF OFF	ON ON (ON) (ON) (ON)	5-6	OPEN	5-4	SPDT
DP	G22 G23 G25 G28 G29	ON ON ON (ON) ON	NONE OFF NONE OFF OFF	ON ON (ON) (ON) (ON)	5-6 2-3	OPEN	5-4 2-1	DPDT

Note: Terminal numbers are not actually on the switch.

Toggles
Rockers
Pushbuttons
Illuminated PB
Programmable
Keylocks
Rotaries
Slides
Tactiles
Tilt
Touch
Indicators
Accessories
Supplement

ACTUATOR

K Snap Top for Rocker

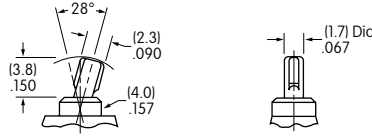

PC TERMINALS

P Straight

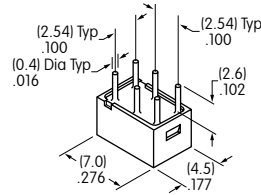

ROCKER CAP & COLORS

Y AT4062 Rocker

Material: Polyamide
Finish: Matte

Colors Available:
A, B, C

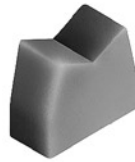

Actual Size

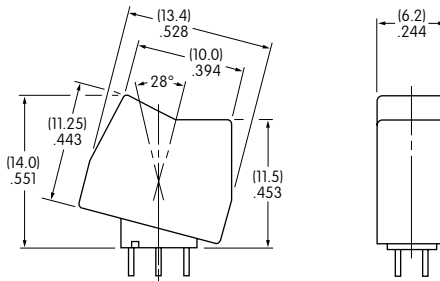

Color Codes: **A** Black **B** White **C** Red

TYPICAL SWITCH DIMENSIONS

Single & Double Pole

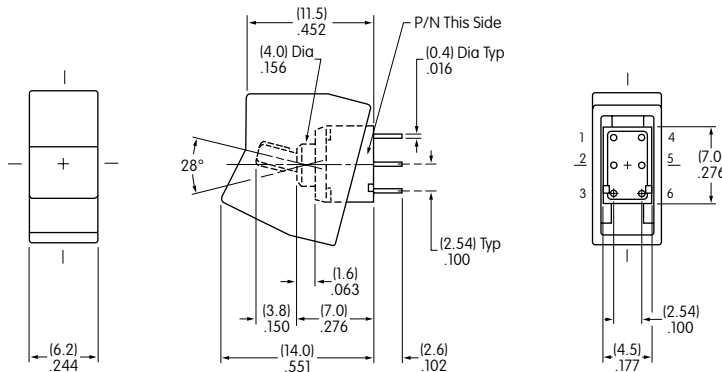

Straight PC

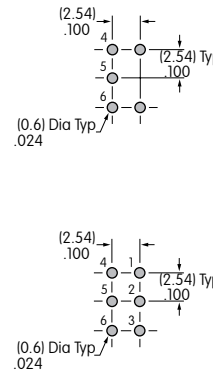

On single pole models positions 1 & 3 are support pins.

G23KP-YA

General Specifications

Toggles

Rockers
B

Pushbuttons

Illuminated PB

Programmable

Keylocks

Rotaries

Slides

Tactiles

Tilt

Touch

Indicators

Accessories

Supplement

Electrical Capacity (Resistive Load)

Logic Level: 0.4VA maximum @ 28V AC/DC maximum
(Applicable Range 0.1 mA ~ 0.1 A @ 20mV ~ 28V)
Note: Find additional explanation of operating range in Supplement section.

Other Ratings

Contact Resistance: 80 milliohms maximum
Insulation Resistance: 500 megohms minimum @ 500V DC
Dielectric Strength: 500V AC minimum for 1 minute minimum
Mechanical Life: 50,000 operations minimum
Electrical Life: 50,000 operations minimum
Nominal Operating Force: For Rockers 1.70N; for Paddles 1.30N
Angle of Throw: 28°

Materials & Finishes

Actuator: Glass fiber reinforced polyamide (UL94V-0)
Case: Glass fiber reinforced polyamide (UL94V-0)
Sealing Ring: Nitrile butadiene rubber
Movable Contact: Phosphor bronze with gold plating
Stationary Contacts: Phosphor bronze with gold plating
Base: Glass fiber reinforced polyamide (UL94V-0)
Mounting Bracket: Phosphor bronze with tin plating
Terminals: Phosphor bronze with gold plating

Environmental Data

Operating Temperature Range: -30°C through +85°C (-22°F through +185°F)
Humidity: 90 ~ 95% humidity for 240 hours @ 40°C (104°F)
Vibration: 10 ~ 55Hz with peak-to-peak amplitude of 1.5mm traversing the frequency range & returning in 1 minute; 3 right angled directions for 2 hours
Shock: 50G (490m/s²) acceleration (tested in 6 right angled directions, with 5 shocks in each direction)

PCB Processing

Soldering: Wave Soldering Recommended: See Profile A in Supplement section.
Manual Soldering: See Profile A in Supplement section..
Cleaning: These devices are not process sealed. Hand clean locally using alcohol based solution.

Standards & Certifications

Flammability Standards: UL94V-0 actuator & case/base

The GW Series rockers have not been tested for UL recognition or CSA certification. These switches are designed for use in a low-voltage, low-current, logic-level circuit. When used as intended in a logic-level circuit, the results do not produce hazardous energy.

Distinctive Characteristics

Various colored rockers and paddles.

Combination of dust cover and closely fit housing, actuator, and interior pivot provides protection for contacts.

Detent mechanism design of coil spring, plunger, and plastic detent results in crisp and positive actuation.

Extremely thin size allows high density PCB mounting and makes these switches ideal for handheld equipment.

Award-winning STC contact mechanism with benefits unavailable in conventional mechanisms: smoother, positive detent actuation, increased contact stability and unparalleled logic-level reliability. (Additional STC details in Terms & Acronyms; see Supplement section.)

Molded-in, epoxy sealed terminals lock out flux and other contaminants.

.100" x .100" (2.54mm x 2.54mm) terminal spacing conforms to standard PC board grid spacing for straight and angle mounting.



Actual Size

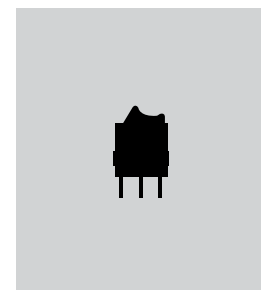

TYPICAL SWITCH ORDERING EXAMPLE

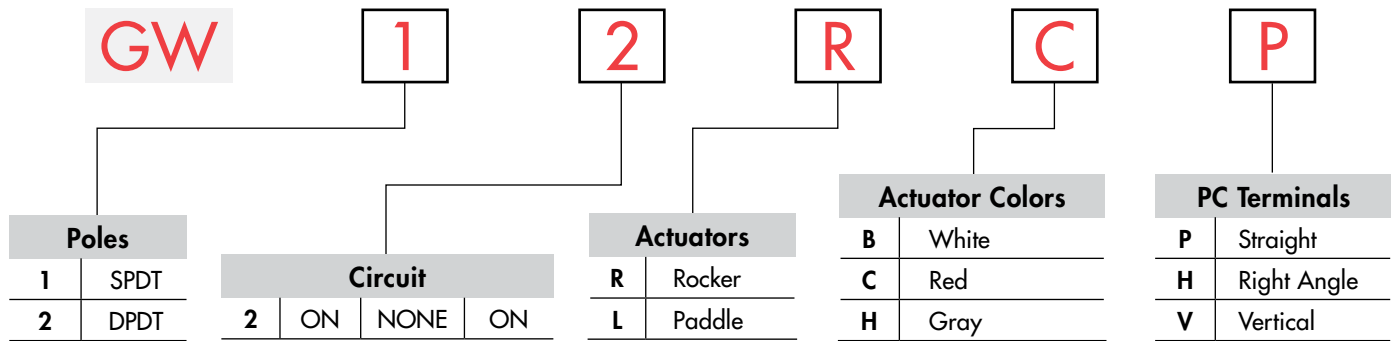

DESCRIPTION FOR TYPICAL ROCKER ORDERING EXAMPLE

GW12RCP

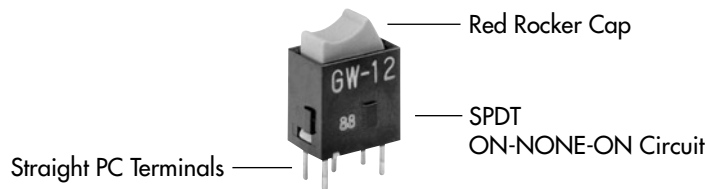

POLES & CIRCUIT

Pole	Model	Rocker Position			Connected Terminals			Throw & Schematics
		Up	Center	Down	Up	Center	Down	
SP	GW12	ON	NONE	ON	5-6	OPEN	5-4	SPDT
DP	GW22	ON	NONE	ON	5-6 2-3	OPEN	5-4 2-1	DPDT

Note: Terminal numbers are not actually on the switch.

TYPICAL SWITCH DIMENSIONS

Straight PC



GW12RCP

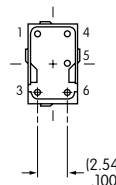
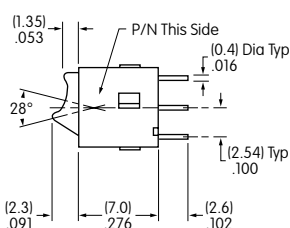
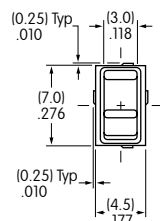

Single Pole

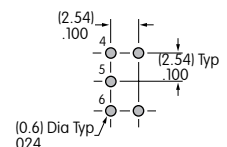

On single pole models positions 1 & 3 are support pins.

Straight PC



GW22LCP

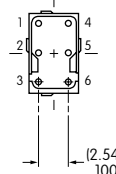
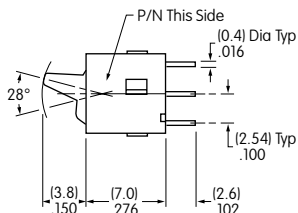
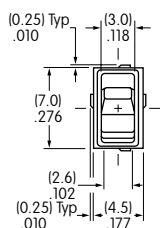

Double Pole

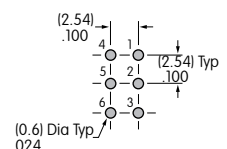

TYPICAL SWITCH DIMENSIONS

Single Pole

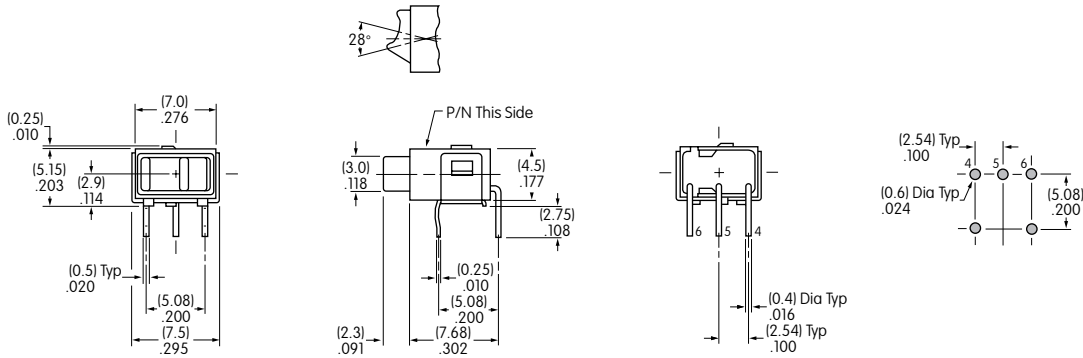

GW12RCH

Double Pole

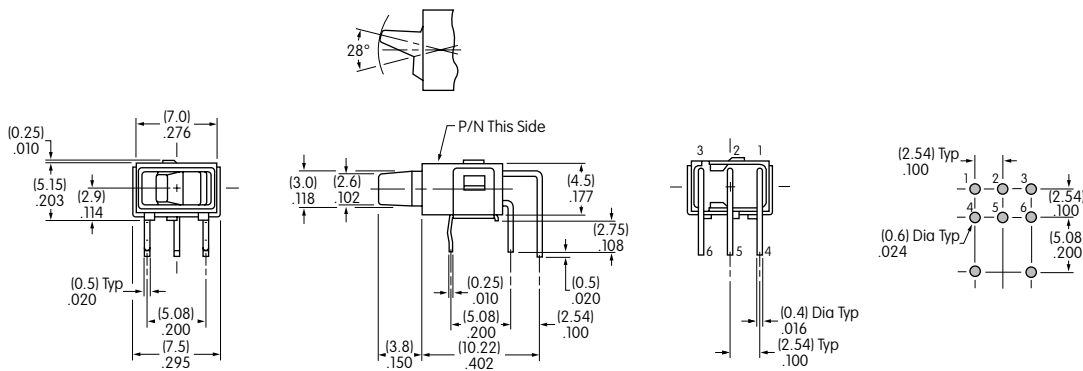

GW22LCH

Single Pole

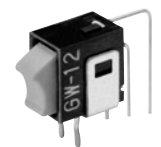
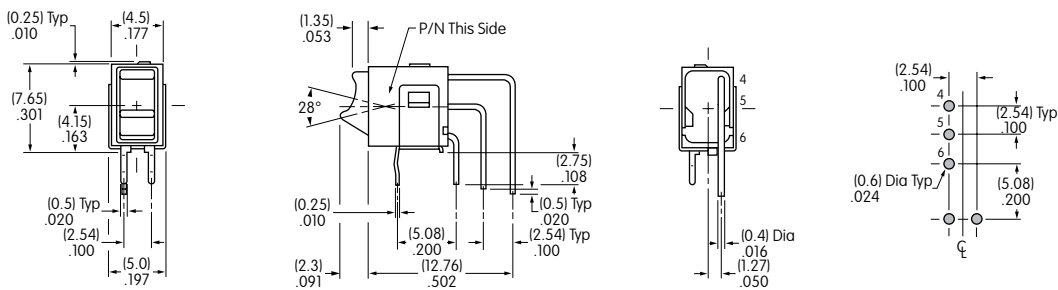

GW12RCV

Double Pole

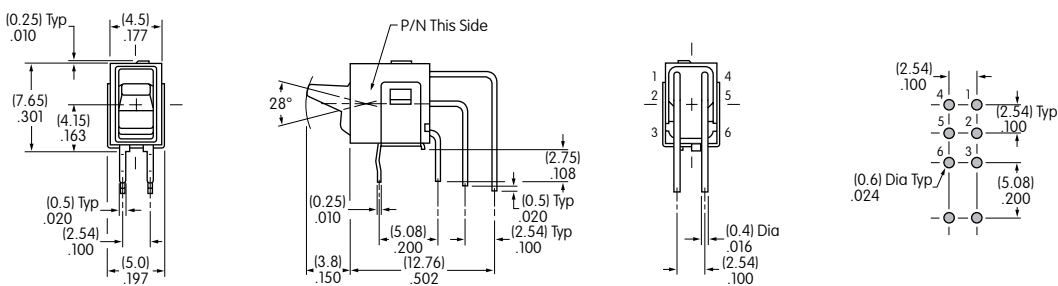

GW22LCV

Toggles

B Rockers

Pushbuttons

Illuminated PB

Programmable

Keylocks

Rotaries

Slides

Tactiles

Tilt

Touch

Indicators

Accessories

Supplement

General Specifications

Toggles

Rockers

Pushbuttons

Illuminated PB

Programmable

Keylocks

Rotaries

Slides

Tactiles

Tilt

Touch

Indicators

Accessories

Supplement

B Electrical Capacity (Resistive Load)

Logic Level: 0.4VA maximum @ 28V AC/DC maximum
(Applicable Range 0.1mA ~ 0.1A @ 20mV ~ 28V)
Note: Find additional explanation of operating range in Supplement section.

Other Ratings

Contact Resistance: 80 milliohms maximum
Insulation Resistance: 500 megohms minimum @ 500V DC
Dielectric Strength: 500V AC minimum for 1 minute minimum
Mechanical Life: 50,000 operations minimum
Electrical Life: 50,000 operations minimum
Nominal Operating Force: 1.0N
Angle of Throw: 28°

Materials & Finishes

Actuator: Polycarbonate resin (UL94V-0)
Case: Glass fiber reinforced polyamide (UL94V-0)
Sealing Ring: Nitrile butadiene rubber
Base: Glass fiber reinforced polyamide
Movable Contact: Phosphor bronze with gold plating
Stationary Contact: Phosphor bronze with gold plating
Terminals: Phosphor bronze with gold plating

Environmental Data

Operating Temperature Range: -25°C through +55°C (-13°F through +131°F)
Humidity: 90 ~ 95% humidity for 240 hours @ 40°C (104°F)
Vibration: 10 ~ 55Hz with peak-to-peak amplitude of 1.5mm traversing the frequency range & returning in 5 minutes; 3 right angled directions for 2 hours
Shock: 50G (490m/s²) acceleration (tested in 3 right angled directions, with 5 shocks in each direction)

PCB Processing

Soldering: Wave Soldering recommended. See Profile A in Supplement section.
Manual Soldering: See Profile A in Supplement section.
Cleaning: These devices are not process sealed. Hand clean locally using alcohol based solution.

Standards & Certifications

Flammability Standard: UL94V-0 actuator & case

The GW Series illuminated paddles have not been tested for UL recognition or CSA certification. These switches are designed for use in a low-voltage, low-current, logic-level circuit. When used as intended in a logic-level circuit, the results do not produce hazardous energy.

Distinctive Characteristics

World's smallest fully illuminated paddles (patent pending) for highly visible status indication; LEDs available in red, green, or amber for single color and red/green for bicolor.

Specially designed switching mechanism provides crisp actuation feedback to positively indicate circuit transfer (patent pending).

Insert molded terminals prevent entry of flux and other contaminants.

Award-winning STC contact mechanism with benefits unavailable in conventional mechanisms: smoother, positive detent actuation, increased contact stability, and unparalleled logic-level reliability. (Additional STC details in Terms & Acronyms; see Supplement section.)

.100" x .100" (2.54mm x 2.54mm) terminal spacing conforms to standard PC board grid spacing for straight and angle mounting.



Actual Size

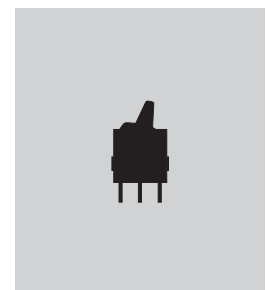

- Toggles
- B** Rockers
- Pushbuttons
- Illuminated PB
- Programmable
- Keylocks
- Rotaries
- Slides
- Tactiles
- Tilt
- Touch
- Indicators
- Accessories
- Supplement

TYPICAL SWITCH ORDERING EXAMPLE

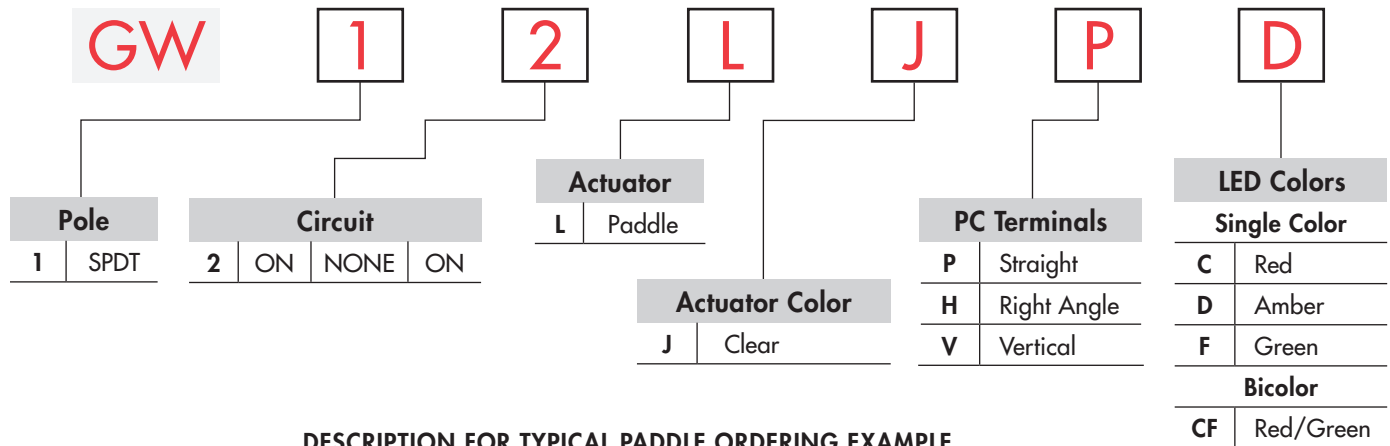

DESCRIPTION FOR TYPICAL PADDLE ORDERING EXAMPLE

GW12LJPD

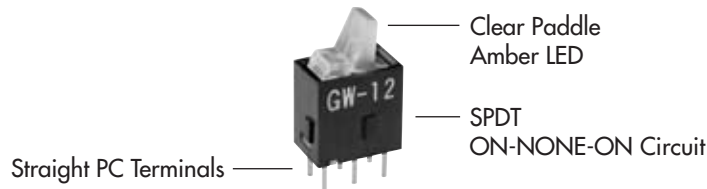

POLE & CIRCUIT

Pole	Model	Paddle Position			Connected Terminals			Throw & Schematics
		Up	Center	Down	Up	Center	Down	
SP	GW12	ON	NONE	ON	2-3	OPEN	2-1	Note: Terminal numbers are not actually on the switch. LED circuit is isolated and requires an external power source. SPDT Single Color Bicolor

LED COLORS & SPECIFICATIONS

LEDs are an integral part of the the switch and not available separately. The electrical specifications shown are determined at a basic temperature of 25°C. If the source voltage exceeds the rated voltage, a ballast resistor is required. The resistor value can be calculated by using the formula in the Supplement section.

	Colors	Single Color			Bicolor
		C	D	F	CF
		Red	Amber	Green	Red/Green
Forward Peak Current	I_{FM}	30mA	30mA	25mA	30mA/25mA
Typical Forward Current	I_F	20mA	20mA	20mA	20mA/20mA
Forward Voltage	V_F	2.0V	2.0V	2.1V	2.0V/2.1V
Reverse Peak Voltage	V_{RM}	5V	5V	5V	5V/5V
Current Reduction Rate Above 25°C	ΔI_F	0 – No Current Reduction Rate within Ambient Temperature Range			
Ambient Temperature Range		-25°C ~ +55°C			

TYPICAL SWITCH DIMENSIONS

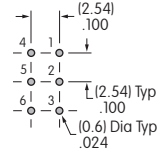
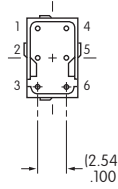
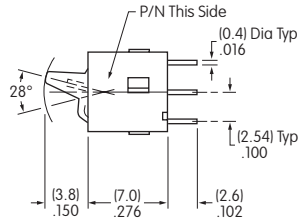
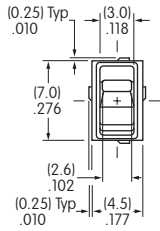

Straight PC



5 & 6 are LED terminals; 4 is a support pin on single color models & an LED terminal on bicolor models.

GW12LJPC

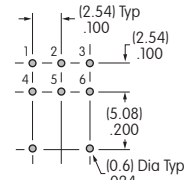
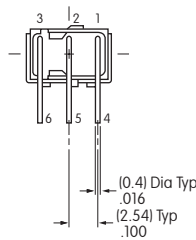
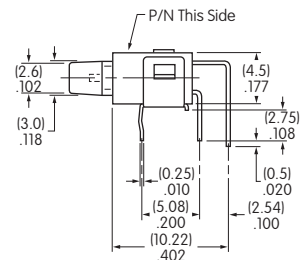
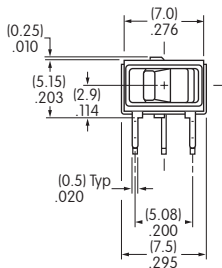
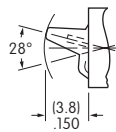

Right Angle PC



5 & 6 are LED terminals; 4 is a support pin on single color models & an LED terminal on bicolor models.

GW12LJHD

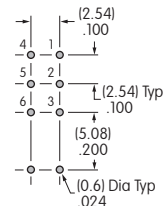
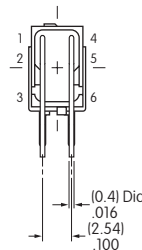
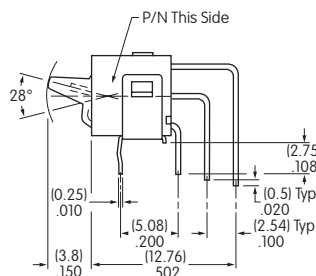
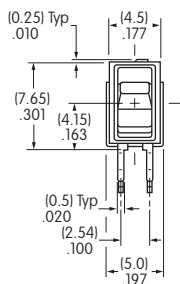

Vertical PC



5 & 6 are LED terminals; 4 is a support pin on single color models & an LED terminal on bicolor models.

GW12LJVCF

General Specifications

Electrical Capacity (Resistive Load)

Power Level: 10A @ 125/250V AC for JWM & JWMW models; 10A @ 30V DC for JWMW;
16A @ 125/250V AC for JWL & JWLW models; 5A @ 72V DC for telecommunication applications

Other Ratings

Contact Resistance: 10 milliohms maximum for JWM & JWMW; 20 milliohms maximum for JWL & JWLW
Insulation Resistance: 1,000 megohms minimum @ 500V DC
Dielectric Strength: 2,000V AC minimum between contacts for 1 minute minimum;
4,000V AC minimum between contacts & case for 1 minute minimum
Mechanical Life: 25,000 operations minimum
Electrical Life: 25,000 operations minimum
Nominal Operating Force: JWM & JWMW Single Pole 3.92N & Double Pole 7.84N
JWL Single Pole 5.00N & Double Pole 10.00N; JWLW Double Pole 10.00N
Angle of Throw: 26°

Materials & Finishes

Rocker: Polyphenylene ether (UL94V-0) **Case/Base:** Melamine (UL94V-0)
Housing/Frame & Barrier: Polyamide (UL94V-0) **Contacts:** Silver alloy with silver plating
Interior Seal for JWM & JWL: Polyphenylene sulfide (UL94V-0) **Terminals:** Brass with silver plating

Environmental Data

Operating Temperature Range: -25°C through +70°C (-13°F through +158°F) for JWM & JWL;
-25°C through +85°C (-13°F through +185°F) for panel seal JWMW & JWLW models
Humidity: 90 ~ 95% humidity for 96 hours @ 40°C (104°F)
Vibration: 10 ~ 55Hz with peak-to-peak amplitude of 1.5mm traversing the frequency range & returning in 1 minute; 3 right angled directions for 2 hours
Shock: 50G (490m/s²) acceleration (tested in 6 right angled directions, with 5 shocks in each direction)
Sealing: IP67 of IEC60529 standard for panel seal JWMW & JWLW models; dust resistant inner seal for others

Installation

Soldering Time & Temperature: Manual Soldering: See Profile A in Supplement section.

Standards & Certifications

Flammability Standards: UL94V-0 for rocker, housing, seal & case/base of JWL, JWM, JWMW & JWLW models
TV Ratings for UL & CSA: JWM (TV-5) Overload Test @ 120V AC for 50 operations:
Steady State Current (rms) 7.5A; Minimum Inrush Current (peak) 111A.
JWM (TV-5) Endurance Test @ 120V AC for 25,000 operations:
Steady State Current (rms) 5A; Minimum Inrush Current (peak) 78A.
JWL (TV-8) Overload Test @ 120V AC for 50 operations:
Steady State Current (rms) 12A; Minimum Inrush Current (peak) 163A.
JWL (TV-8) Endurance Test @ 120V AC for 25,000 operations:
Steady State Current (rms) 8A; Minimum Inrush Current (peak) 117A.

UL: File No. E44145
JWM & JWMW models recognized at 10A @ 250V AC.
JWMW recognized at 10A @ 30V DC.
JWL & JWLW models recognized at 16A @ 250V AC; JWL at 5A @ 72V DC.

Models below recognized only when ordered with marking on switch.

JWMW: add "/U" to end of part number to order UL mark on switch; add "/CUL" to end of part number to order cULus mark on switch.
JWL: add "/U-DC" to end of part number to request UL rating on DC rated switch.

CSA: File No. 023535_0_000
JWM & JWMW models certified at 10A @ 250V AC; JWL models certified at 16A @ 250V AC .

VDE: License No. 115637
JWM models approved at steady state 5A, inrush 80A, resistive 10A, & motor load 6A all at 250V AC; JWL models approved at steady state inrush 128A, resistive 16A, & motor load 8A all at 250V AC.
Note: JWM & JWL Double Pole, Single Throw models approved only with the international ON-OFF symbols on the actuator.

Distinctive Characteristics

Industry's first molded rocker with TV rating. Designed to handle large inrush current, with high electrical capacity of 10 and 16 Amps. JWM models certified for TV-5 rating and JWL models for TV-8 rating.

JWMW and JWLV panel seal versions meet IP67 of IEC60529 Standards (similar to NEMA 4 and 6).

Prominent external insulating barriers increase insulation resistance and dielectric strength.

Uniquely constructed to break light contact welds.

Increased electrical life with specially designed plate to minimize contact bounce.

Constructed for dust resistance with interior cover between actuator and contact area.

Terminals are molded in and epoxy sealed to lock out flux, dust, and other contaminants.

Solder lug/quick connect terminals can be used with connector.

Housing and case of heat resistant resin meet UL94V-0 standard.

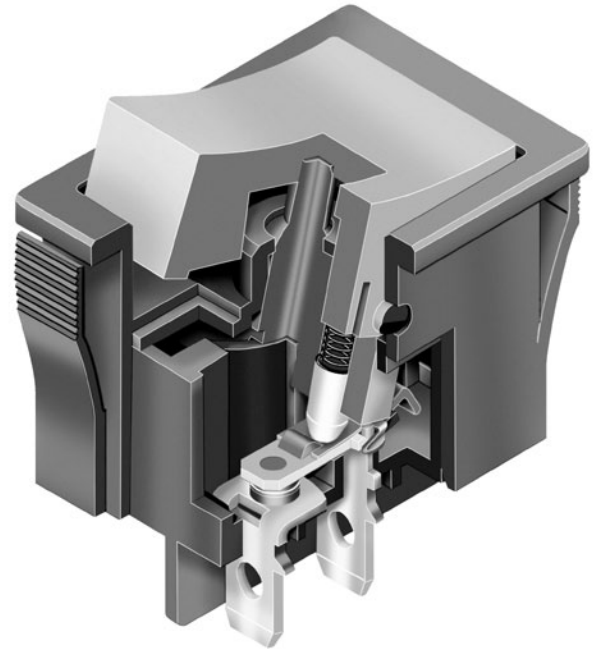

Actual Size JWM



Toggles

B Rockers

Pushbuttons

Illuminated PB

Programmable

Keylocks

Rotaries

Slides

Tactiles

Tilt

Touch

Indicators

Accessories

Supplement

TYPICAL SWITCH ORDERING EXAMPLE

JW **LW** **2** **1** **R** **A** **1** **A** —

M	10A @ 125/250V AC
MW	Panel Seal 10A @ 125/250V AC
L	16A @ 125/250V AC
LW	Panel Seal 16A @ 125/250V AC ← NEW

R	No Barrier
B	With Barrier

Note: JWMW & JWLW combine with code R only.

A	Black
B	Ivory
H	Gray

Note: JWMW & JWLW available with black only.

1	SPST SPDT
2	DPST DPDT

Notes:
DPST must have international ON-OFF symbols for VDE approval.
JWLW available in DPST & DPDT only.

A	Black
B	Ivory
C	Red
H	Gray

Note: JWMW & JWLW available with black or red caps only.

A	Black
B	Ivory
H	Gray

Note: Wire harness & cable assemblies offered only in Americas

	ON	NONE	OFF
1	ON	NONE	OFF
2	ON	NONE	ON

No Code	No Inscription
1	Horizontal
2	Vertical

These are inscriptions for Single Throw models only.

IMPORTANT:

Standard markings for JWM & JWL: TV Rating, UL, CSA & VDE.
Standard marking for JWLW: cULus.
Specific models, ratings, & ordering instructions for international approvals are noted on General Specifications page.

DESCRIPTION FOR TYPICAL ORDERING EXAMPLE

JWLW21RA1A **← NEW**

Black Rocker Cap with International ON-OFF Symbols in Horizontal Orientation

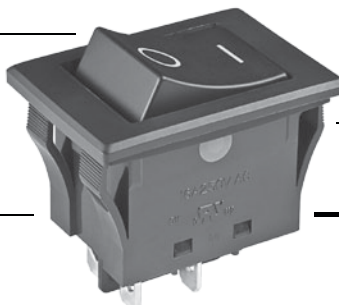

Black Housing

DPST ON-NONE-OFF Circuit

16A @ 125/250V AC

Toggles
Rocker
Pushbuttons
Illuminated PB
Programmable
Keylocks
Rotaries
Slides
Tactiles
Tilt
Touch
Indicators
Accessories
Supplement

RATINGS

M	Power Level	10A @ 125/250V AC	MW	Panel Seal	Power Level	10A @ 125/250V AC
L	Power Level	16A @ 125/250V AC	<i>NEW</i> → LW	Panel Seal	Power Level	16A @ 125/250V AC

POLES & CIRCUITS

Pole	Model	Rocker Position			Connected Terminals			Throw & Schematics
		Down	Center	Up	Down	Center	Up	
SP	JWM11 JMW11 JWL11	ON	NONE	OFF	1-1b	OPEN	OPEN	SPST
SP	JWM12 JMW12 JWL12	ON	NONE	ON	1-1b	OPEN	1-1a	SPDT
DP	JWM21 JMW21 JWL21 JWLW21	ON	NONE	OFF	1-1b 2-2b	OPEN	OPEN	DPST
DP	JWM22 JMW22 JWL22 JWLW22	ON	NONE	ON	1-1b 2-2b	OPEN	1-1a 2-2a	DPDT

BARRIER TYPES & COLORS

R No Barrier



JWM



JWL

B With Barrier



JWM



JWL

No-barrier type has a flat flange which is an integral part of the switch.

JMW and JWLW panel seal devices have exterior seal of acrylonitrile butadiene rubber covering the flange.

Flange/Housing Material: Polyamide Finish: Matte

Barrier type designates that either AT217 (for JWM) or AT218 (for JWL) is factory assembled. Dimensions for barriers are shown in the Accessories section.

Barrier Colors Available: **A** Black **B** Ivory **H** Gray

Barrier Material: Polyamide Finish: Matte

CAP COLORS



Cap Material: Polyphenelene Oxide

Finish: Matte

Cap Colors Available: **A** Black **B** Ivory **C** Red **H** Gray

Rocker cap is an integral part of the switch and not available separately.

JMW and JWLW available with black or red caps only.

Toggles
Rockers
Pushbuttons
Illuminated PB
Programmable
Keylocks
Rotaries
Slides
Tactiles
Tilt
Touch
Indicators
Accessories
Supplement

INSCRIPTIONS

No Code

No Inscription



DPST models without inscriptions do not have VDE approval.

1

Inscription for Horizontal Mounting



2

Inscription for Vertical Mounting



The IEC symbols for On-Off are supplied with Single Throw models only. Orientation of inscription must be selected. Inscription Colors: Black ink on Ivory or Gray cap. White ink on Black or Red cap. Contact factory for other inscriptions.

HOUSING

Material: Polyamide

Finish: Matte

Colors Available:

A Black

B Ivory

H Gray

JWMW and JWLW panel seal models available with black housing only.

TERMINALS

Solder Lug/Quick Connect .110" (2.8mm)

JWM & JWMW

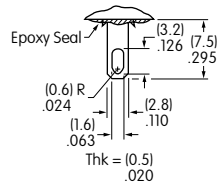

Solder Lug/Quick Connect .187" (4.75mm)

JWL & JWLW

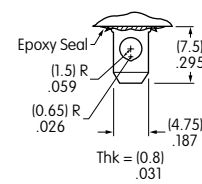

PANEL CUTOUTS

Panel Thickness Range

Without Barrier (JWM & JWMW):
.039" ~ .157" (1.0mm ~ 4.0mm)

With Barrier (JWM):
.024" ~ .126" (0.6mm ~ 3.2mm)

JWM

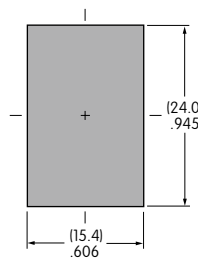

JWMW

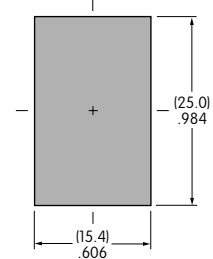

Panel Thickness Range

Without Barrier (JWL & JWLW):
.039" ~ .157" (1.0mm ~ 4.0mm)

With Barrier (JWL):
.024" ~ .126" (0.6mm ~ 3.2mm)

JWL

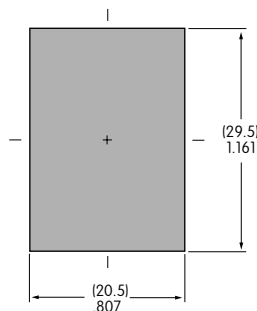

JWLW

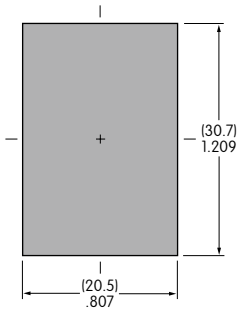

TYPICAL SWITCH DIMENSIONS FOR JWM & JMW

Single & Double Pole

No Barrier • 10 Amp

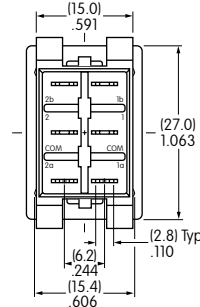
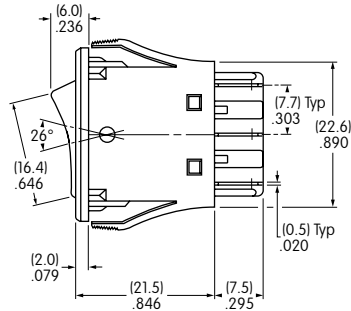
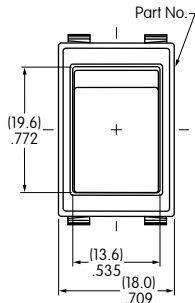

JWM11RC1A

Single & Double Pole

With Barrier • 10 Amp

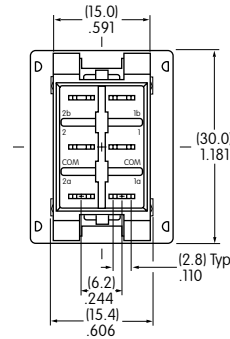
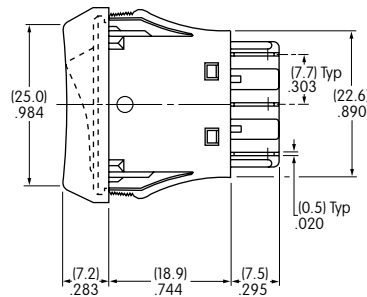
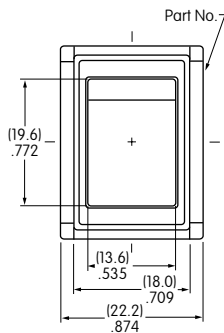

JWM11BCA-H

Single & Double Pole

Panel Seal • No Barrier • 10 Amp

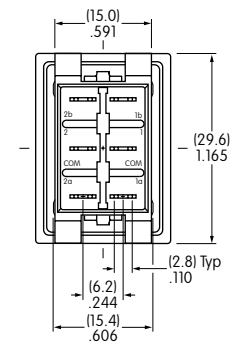
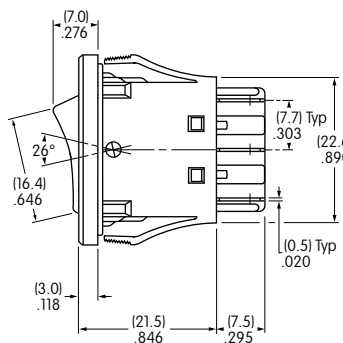
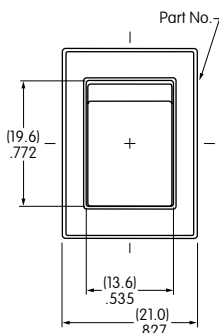

JWMW22RCA

Single pole double throw models do not have terminals 2a, 2, & 2b; single throw models do not have 1a & 2a.

TYPICAL SWITCH DIMENSIONS FOR JWL & JWLW

No Barrier • 16 Amp

Single & Double Pole

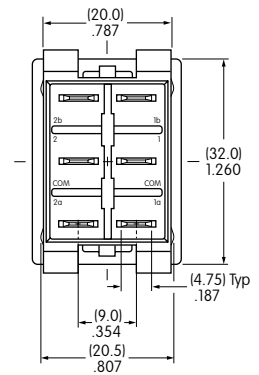
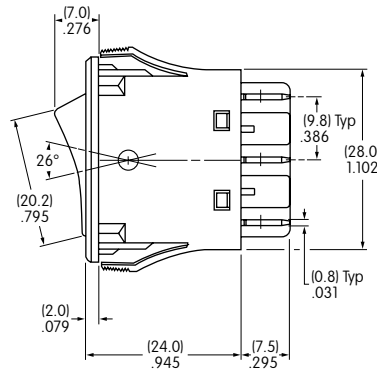
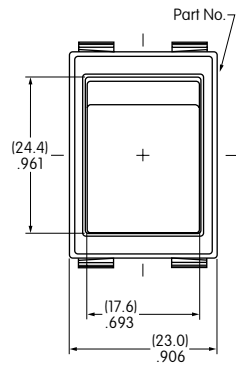

JWL21RC2A

Single pole double throw models do not have terminals 2a, 2, & 2b; single throw models do not have 1a & 2a.

With Barrier • 16 Amp

Single & Double Pole

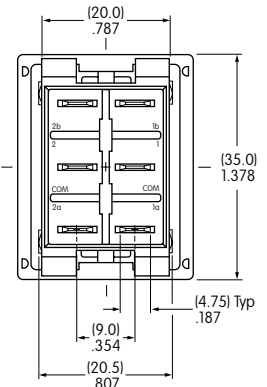
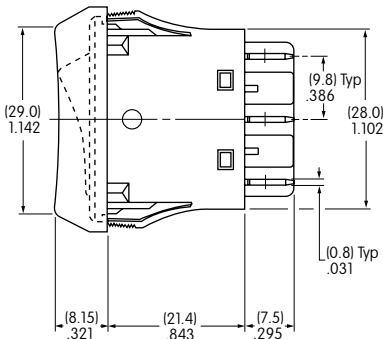
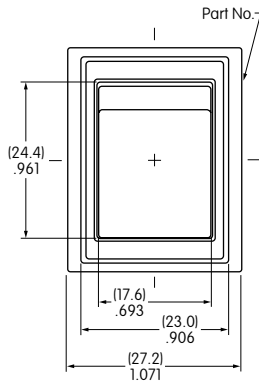

JWL11BCA-H

Single pole double throw models do not have terminals 2a, 2, & 2b; single throw models do not have 1a & 2a.

Panel Seal • 16 Amp • Inscription ← NEW

Double Pole Single Throw

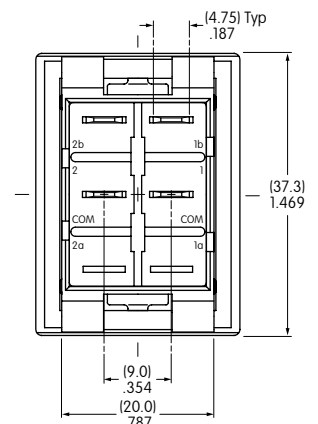
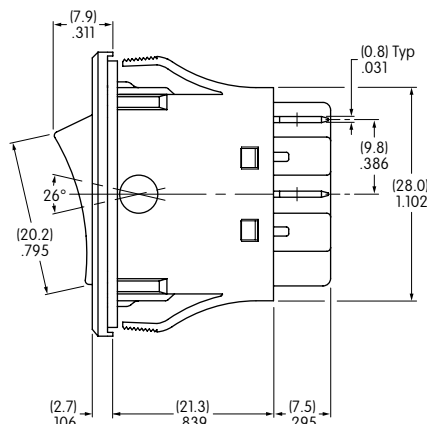
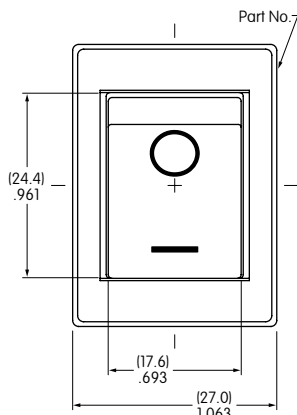

JWLW21RA1A

TYPICAL SWITCH DIMENSIONS FOR JWLW

Double Pole Double Throw

NEW → Panel Seal • 16 Amp • No Inscription

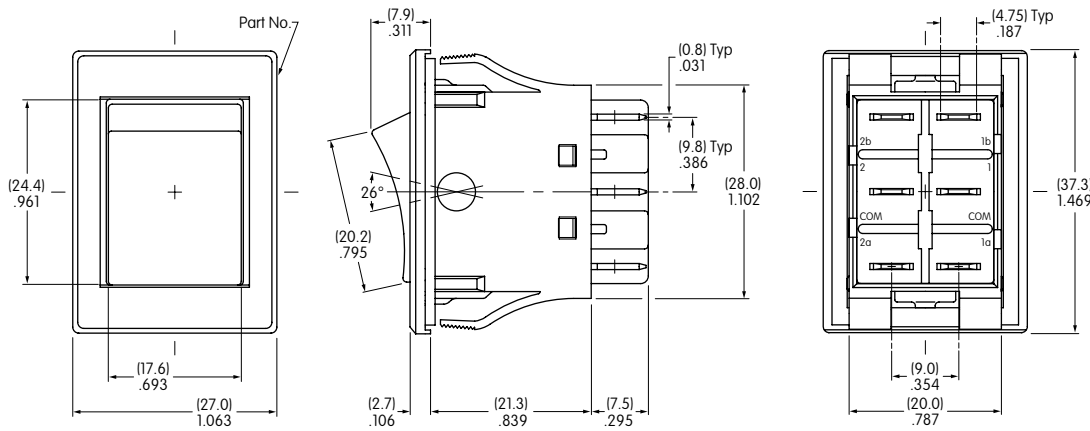

JWLW22RAA

OPTIONAL DUST COVER

AT4126

Dust Cover for JWL Rocker

When installed, the Dust Cover protects the switch from an environment containing small particles and dust. The switch is operable with the Dust Cover in place.

Materials:

Lid: Clear Polyvinyl Chloride
Base: Black Polyamide

Recommended Temperature Range:

-10° ~ +70°C (+14°F ~ +158°F)
Loses pliability below 0°C (+32°F)

Recommended Panel Thickness:

.031" ~ .134" (0.8mm ~ 3.4mm)

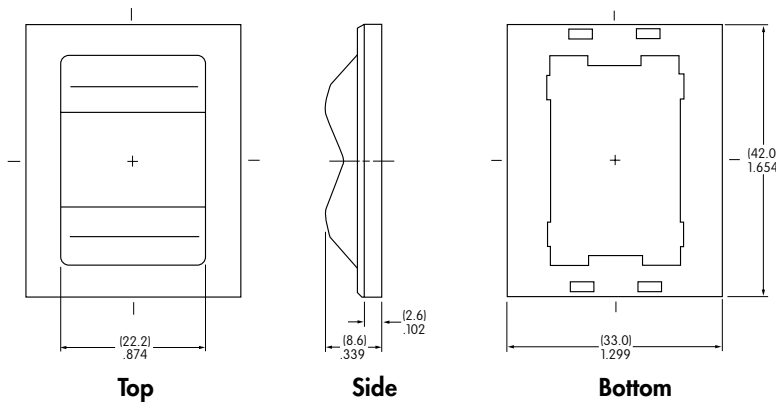
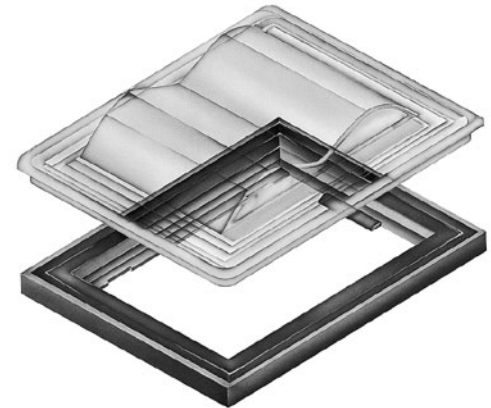

Assembly Instructions:

1. Insert bottom of switch through the base until the tabs lock into place.
2. Snap the switch into the panel.
3. Seat the lid into the grooves of the base.

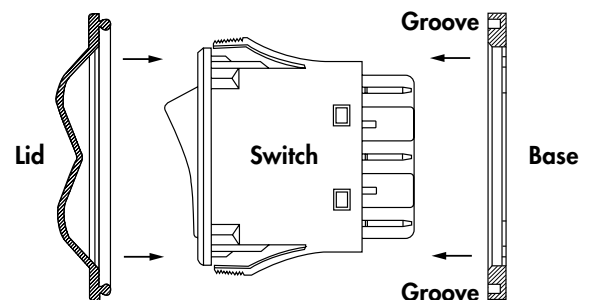

Notes

1. The dust cover is not for use with JWLW.
2. The dust cover cannot be used with the barrier option.

PRECAUTIONS FOR HANDLING & STORAGE FOR JMW/LW (PANEL SEAL TYPES)

Operating Environment

- Do not install switch where heavy dust collection occurs. Dust build-up under rocker may affect switch actuation.
- Do not actuate switch if submerged in water or oil.
- Installation is not recommended on horizontal surface in an environment where frequent splashing of water may occur. In such an environment, a minimum 30° angle installation is advisable. If there is a possibility of freezing, install vertically so no moisture will be retained within switch housing.

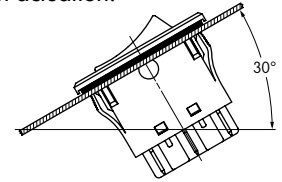

Panel Mounting

- Before snapping a switch into the panel, align the gasket evenly under bezel of the switch.
- When mounting into a panel, apply equal pressure to sides of bezel and insert parallel to panel.
- After mounting a switch, be sure there are no gaps between switch and panel. Lightly push into panel.
- After installing into panel, do not apply excessive force.
- After panel installation and wiring is completed, do not apply force horizontally or vertically from behind panel.
- Behind the panel, cut area should be squared. If front of panel is painted, do not allow any paint to collect in corners of cutout to prevent level mounting.
- Avoid reinstalling a switch once it has been mounted in a panel. This may cause deterioration of panel sealability.

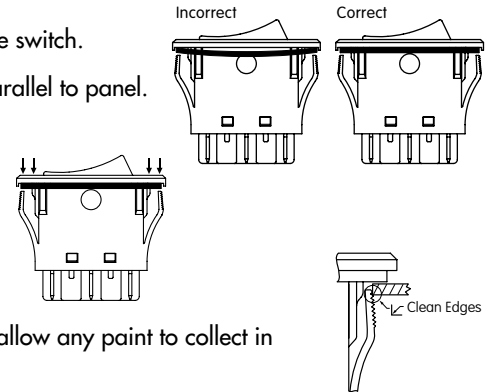

General Specifications

Electrical Capacity (Resistive Load)

Power Level: 10A @ 125/250V AC
6A @ 125/250V AC (UL/CSA)
5A (3A) @ 125/250V AC (VDE)

Other Ratings

Contact Resistance: 10 milliohms maximum
Insulation Resistance: 500 megohms minimum @ 500V DC
Dielectric Strength: 2,000V AC minimum between contacts for 1 minute minimum;
4,000V AC minimum between contacts & case for 1 minute minimum
Mechanical Life: 30,000 operations minimum
Electrical Life: 10,000 operations minimum
Nominal Operating Force: Single Pole 3.92N & Double Pole 5.39N
Angle of Throw: 30°

Materials & Finishes

Rocker: Polyphenylene ether (UL94V-0)
Housing/Case: Polyamide (UL94V-0)
Movable Contact: Copper with silver plating
Movable Contacts: Silver
Stationary Contacts: Silver
End Terminals: Brass with silver plating
Common Terminals: Copper with silver plating
Lamp Terminals: Phosphor bronze with tin plating (illuminated models only)

Environmental Data

Operating Temp Range: -25°C through +70°C (-13°F through +158°F) for nonilluminated models;
-25°C through +50°C (-13°F through +122°F) for illuminated models
Humidity: 90 ~ 95% humidity for 96 hours @ 40°C (104°F)
Vibration: 10 ~ 55Hz with peak-to-peak amplitude of 1.5mm traversing the frequency range & returning in 15 minutes; 3 right angled directions for 2 hours
Shock: 50G (490m/s²) acceleration (tested in 6 right angled directions, with 5 shocks in each direction)
Sealing: Dust resistant inner seal

Installation

Soldering: Manual Soldering: See Profile A in Supplement section.
Cleaning: These devices are not process sealed. Hand cleaning locally using alcohol based solution.

Standards & Certifications

Flammability Standards: UL94V-0 for rocker & housing/case
UL: File No. E44145
All JWS models recognized at 6A @ 125/250V AC
CSA: File No. 023535_0_000
All JWS models certified at 6A @ 125/250V AC
VDE: License No. 119153
All JWS models approved at 5A (3A) @ 125/250V AC

Distinctive Characteristics

Rocker caps and housing available in a variety of colors.

Protective barrier available to prevent accidental actuation.

Constructed for dust resistance with interior cover of polyamide between actuator and contact area.

Easy, crisp actuation.

Small size well suited for telecommunication, measuring, automation, and consumer applications.

Terminals are molded in to lock out flux, dust, and other contaminants.

Outer case of heat resistant resin meets UL94V-0 flammability standard.

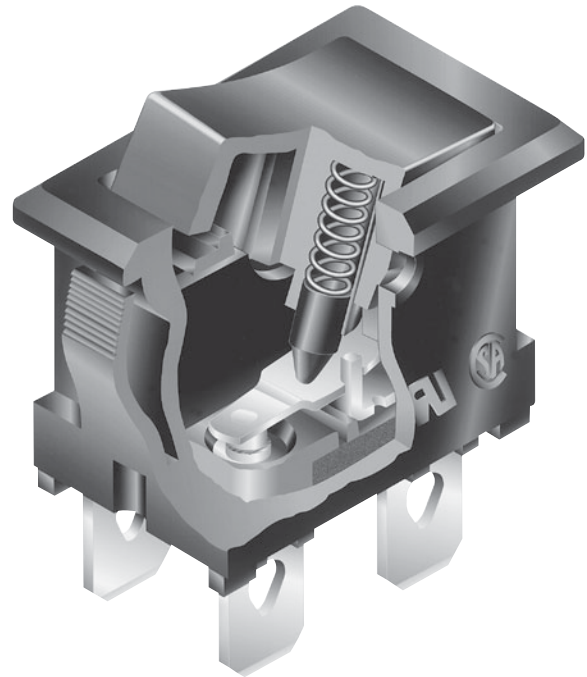

Actual Size

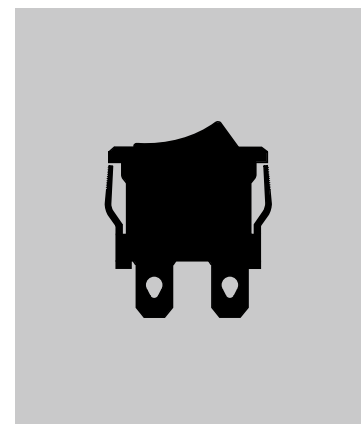

Toggles
B Rockers
Pushbuttons
Illuminated PB
Programmable
Keylocks
Rotaries
Slides
Tactiles
Tilt
Touch
Indicators
Accessories
Supplement

TYPICAL SWITCH ORDERING EXAMPLE

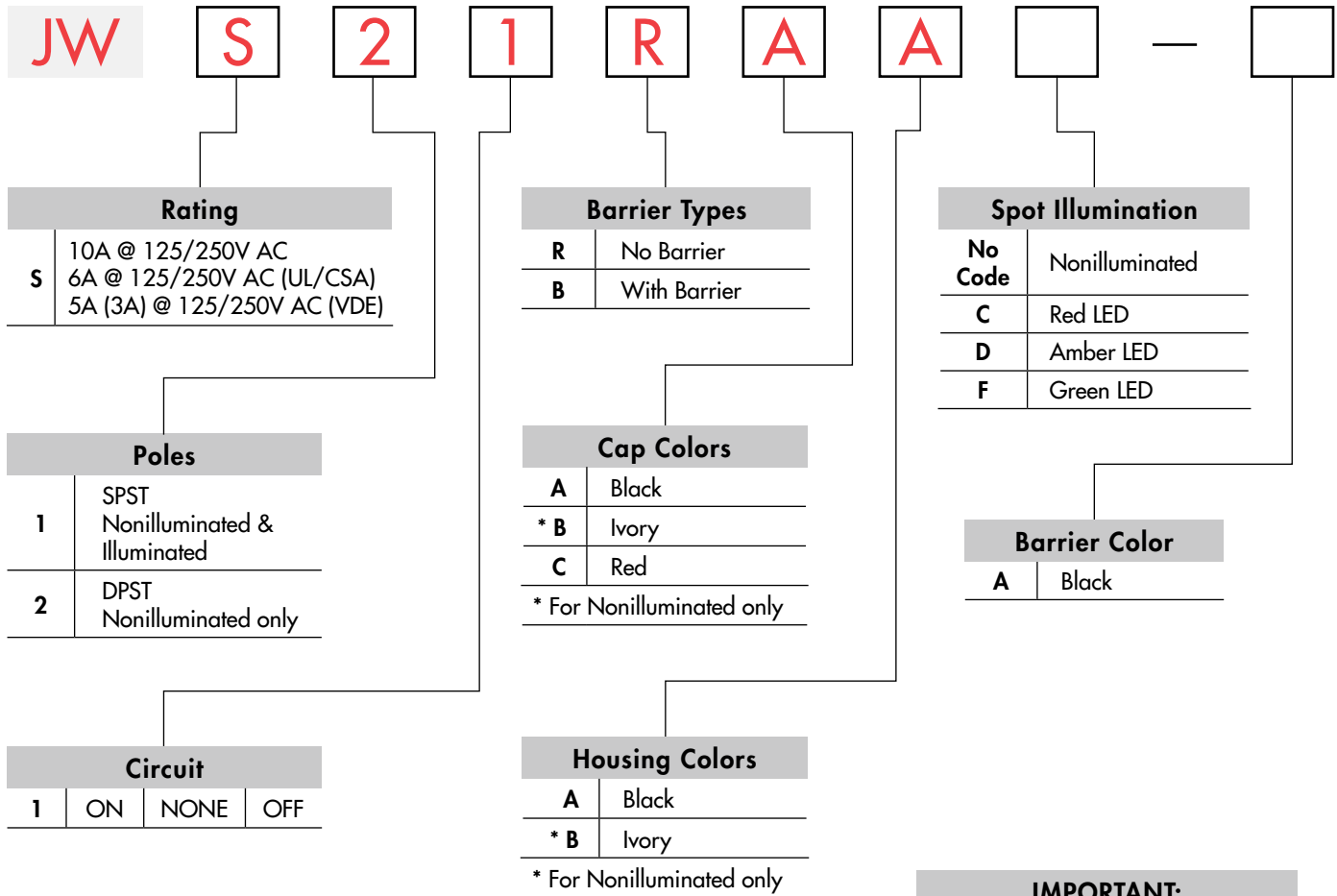

Note: Wire harness & cable assemblies offered only in Americas

IMPORTANT:

 cULus & VDE markings are standard on all models. Models & specific ratings are noted on General Specifications page.

DESCRIPTION FOR TYPICAL ORDERING EXAMPLE

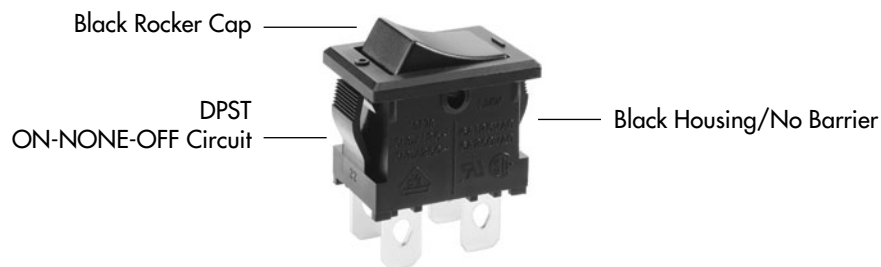
JWS21RAA





Toggles
Rocker
Pushbuttons
Illuminated PB
Programmable
Keylocks
Rotaries
Slides
Tactiles
Tilt
Touch
Indicators
Accessories
Supplement

RATING

S	Power Level	10A @ 125/250V AC	6A @ 125/250V AC (UL/CSA)	5A (3A) @ 125/250V AC (VDE)
----------	--------------------	-------------------	---------------------------	-----------------------------

POLES & CIRCUITS

Pole	Model	Rocker Position			Connected Terminals			Throw & Schematics
		Down	Center	Up	Down	Center	Up	
SP	JWS11	ON	NONE	OFF	2-3	OPEN	OPEN	SPST 
DP	JWS21	ON	NONE	OFF	1-3 4-6	OPEN	OPEN	DPST 

BARRIER TYPES & COLORS

R No Barrier

No-barrier type has a flat flange which is an integral part of the switch.



B With Barrier

Barrier Material: Polyamide
Finish: Matte

Barrier AT219 is factory assembled. Dimensions for barrier are shown in the Accessories section.



Barrier Color Available: **A** Black

CAP COLORS



Cap Material: Polyphenylene Oxide

Finish: Matte

Rocker cap is an integral part of the switch and not available separately.
* Ivory for nonilluminated models only.

Cap Colors Available:

A Black

B * Ivory

C Red

HOUSING

Material: Polyamide
Finish: Matte

Colors Available:

A Black

B Ivory (for nonilluminated models only)

TERMINALS

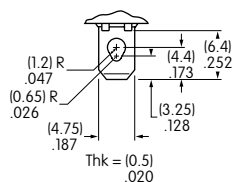

Switch

Solder Lug / .187" (4.75mm) Quick Connect

Switch assembly with connectors is not UL, CSA, C-UL, or VDE approved.

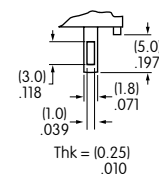

Lamp
(spot illuminated models only)

Toggles
Rockers
Pushbuttons
Illuminated PB
Programmable
Keylocks
Rotaries
Slides
Tactiles
Tilt
Touch
Indicators
Accessories
Supplement

LED COLORS & SPECIFICATIONS FOR SPOT ILLUMINATED MODELS

LEDs are supplied as an integral part of illuminated devices and are not available separately. LED polarity markings are on the bottom of the switch.

The electrical specifications shown here are determined at a basic temperature of 25°C.

If the source voltage exceeds the rated voltage, a ballast resistor is required. The resistor value can be calculated by using the formula in the Supplement section.

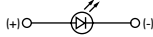
		C	D	F
		Red	Amber	Green
Forward Peak Current	I_{FM}	25mA	20mA	20mA
Typical Forward Current	I_F	20mA	15mA	15mA
Forward Voltage	V_F	2.0V	1.9V	1.95V
Reverse Peak Voltage	V_{RM}	4V	5V	5V
Current Reduction Rate Above 25°C	ΔI_F	0.42mA/°C	0.27mA/°C	0.27mA/°C
Ambient Temperature Range		-25°C ~ +50°C		

PANEL CUTOUT & PANEL THICKNESS RANGES

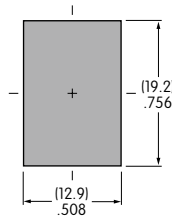

Panel Thickness Ranges:

Without Barrier:
.030" ~ .079" (0.75mm ~ 2.0mm)

With Barrier:
.024" ~ .059" (0.6mm ~ 1.5mm)

TYPICAL SWITCH DIMENSIONS

Nonilluminated • No Barrier

Single Pole

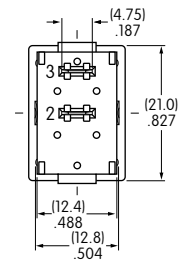
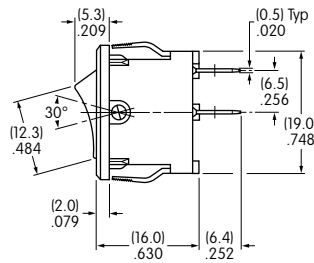
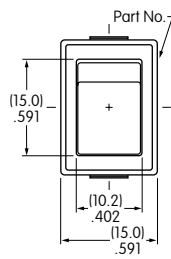

JWS11RCA

Nonilluminated • No Barrier

Double Pole

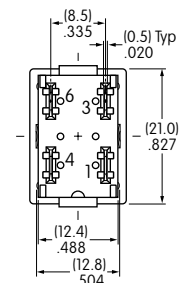
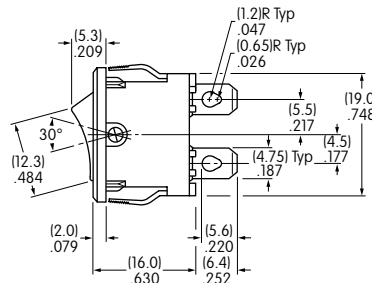
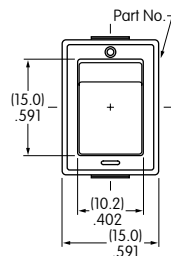

JWS21RAA

DPST models have IEC symbols for On-Off on the flange.

TYPICAL SWITCH DIMENSIONS

Single Pole

Nonilluminated • With Barrier

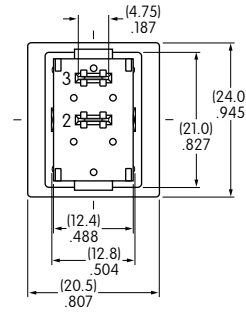
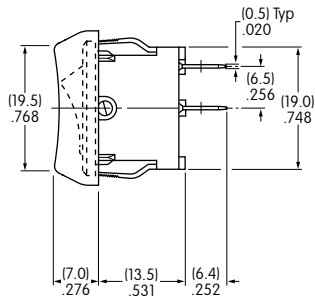
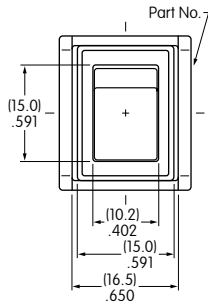

JWS11BBA-A

Double Pole

Nonilluminated • With Barrier

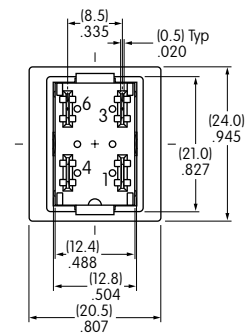
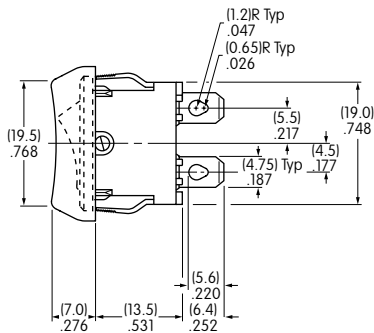
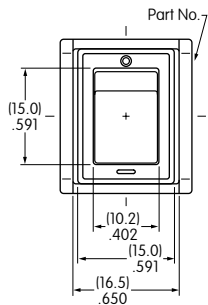

JWS21BAA-A

DPST models have IEC symbols for On-Off on the flange.

Single Pole

Spot Illuminated • No Barrier

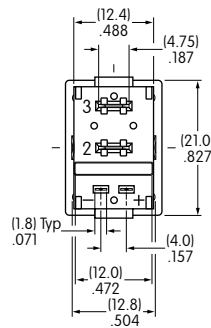
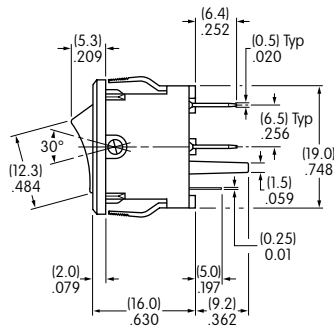
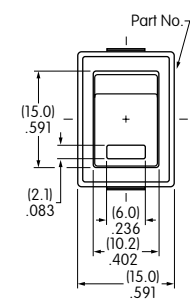

JWS11RCAF

Single Pole

Spot Illuminated • With Barrier

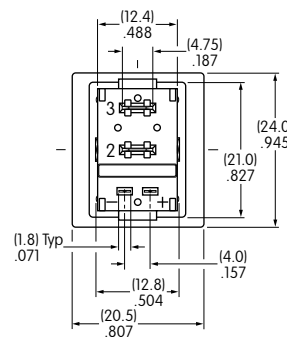
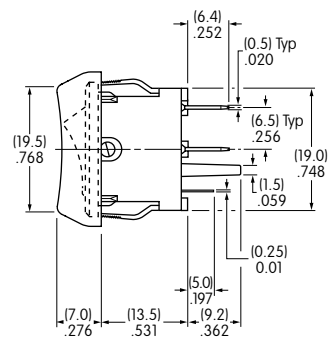
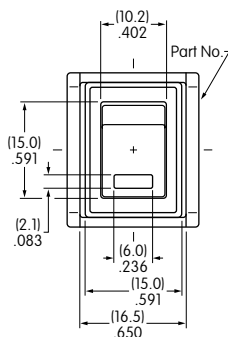

JWS11BAAF-A

Toggles

B Rockers

Pushbuttons

Illuminated PB

Programmable

Keylocks

Rotaries

Slides

Tactiles

Tilt

Touch

Indicators

Accessories

Supplement

General Specifications

Toggles

Rockers

Pushbuttons

Illuminated PB

Programmable

Keylocks

Rotaries

Slides

Tactiles

Tilt

Touch

Indicators

Accessories

Supplement

B Electrical Capacity

Resistive Load: 10A @ 125V AC, 6A @ 250V AC, or 6A @ 30V DC

Inductive Load: 5A @ 125V AC (P. F. @ .60)

Other Ratings

Contact Resistance: 10 milliohms maximum

Insulation Resistance: 200 megohms minimum @ 500V DC

Dielectric Strength: 1,500V AC minimum for 1 minute minimum

Mechanical Life: 30,000 operations minimum

Electrical Life: 10,000 operations minimum

Nominal Operating Force: 11.77N for maintained & 17.65N for momentary

Angle of Throw: 34°

Materials & Finishes

Housing: Steel with chrome plating

Movable Contacts: Silver clad copper with silver plating

Stationary Contacts: Copper with silver plating

Base: Melamine

Common Terminal: Copper with silver plating

End Terminals: Brass with silver plating

Lamp Terminals: Phosphor bronze with nickel plating

Environmental Data

Operating Temperature Range: -20°C through +50°C (-4°F through +122°F)

Humidity: 90 ~ 95% humidity for 96 hours @ 40°C (104°F)

Vibration: 10 ~ 55Hz with peak-to-peak amplitude of 1.5mm traversing the frequency range & returning in 1 minute; 3 right angled directions for 2 hours

Shock: 50G (490m/s²) acceleration (tested in 3 right angled directions, with 3 shocks in each direction)

Installation

Cap Installation Force: 19.61N (4.41 lbf)

Soldering Time & Temperature: Manual Soldering: See Profile A in Supplement section.

Standards & Certifications

UL: File No. E44145 - Recognized only when ordered with marking on switch.
Add "/U" or "/CUL" before first dash in part number to order UL recognized switch.
All models recognized at 10A @ 125V AC & 6A @ 250V AC

Distinctive Characteristics

Each half of the rocker face is distinctly illuminated due to partitioned rocker construction and dual lamps.

Numerous lighting effects achievable by using white or clear rocker with colored filters or lamp covers, plus using different colors on each side of rocker.

Snap-in mounting allows fast, easy installation of switch into panel.

Stainless steel retaining clips provide secure mounting over a wide range of panel thicknesses.

Dual incandescent or neon lamps operate independently of each other.

Front panel relamping.

Stationary lamp sockets are independent of rocker actuation, protecting lamps from damage due to shock and vibration.

Switch contacts are rated at 10 amps 125V AC which makes these devices well-suited for various power switching applications.

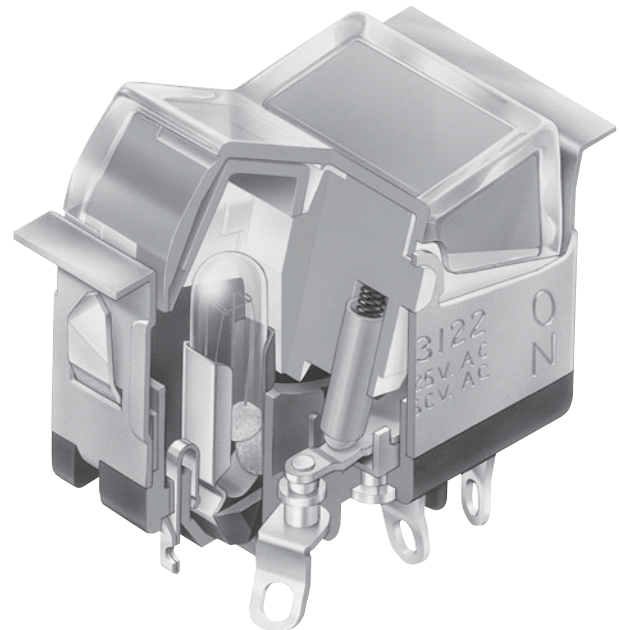

Actual Size

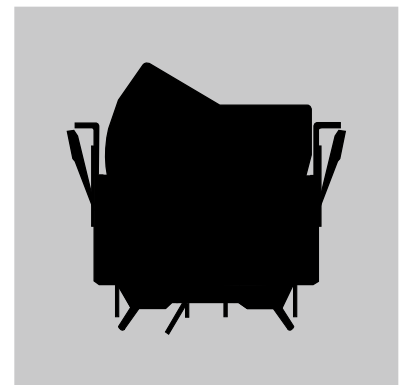

Toggles
B Rockers
Pushbuttons
Illuminated PB
Programmable
Keylocks
Rotaries
Slides
Tactiles
Tilt
Touch
Indicators
Accessories
Supplement

TYPICAL SWITCH ORDERING EXAMPLE

LW31

2

2

H

4

C

F

A

Pole

2	DPDT
----------	------

Circuits

	Up	Center	Down
2	ON	NONE	ON
3	ON	OFF	ON
5	ON	NONE	(ON)
8	(ON)	OFF	(ON)
9	ON	OFF	(ON)

() = Momentary

Lamps

Incandescent	
E	6-volt
F	12-volt
H	18-volt
K	24-volt
L	28-volt
Neon	
N	110-volt
Not suitable with green & blue	
Nonilluminated	
0	No Lamp

Bezel

No Code	No Bezel
A	Black
B	White
C	Red
D	Amber
E	Yellow
F	Green
G	Blue
H	Gray

Rocker Caps

1	White without filters or lamp covers
2	White with filters
3	White with lamp covers
4	Clear with filters

Lamp Cover/Filter Colors For Up Position

0	No Cover/Filter
Lamp Cover	
C	Red
D	Amber
F	Green
Filter	
B	White
C	Red
D	Amber
E	Yellow
F	Green
G	Blue

Lamp Cover/Filter Colors For Down Position

0	No Cover/Filter
Lamp Cover	
C	Red
D	Amber
F	Green
Filter	
B	White
C	Red
D	Amber
E	Yellow
F	Green
G	Blue

Note: Wire harness & cable assemblies offered only in Americas

DESCRIPTION FOR TYPICAL ORDERING EXAMPLE

LW3122-H4CF-A

Clear Rocker with Red Filter in Up Position and Green Filter in Down Position

DPDT ON-NONE-ON Circuit

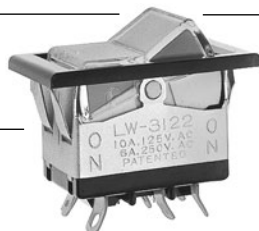

18-volt Incandescent Lamp
Black Bezel

IMPORTANT:



Switches are supplied without UL & cULus marking unless specified. **UL & cULus recognized only when ordered with marking on the switch.** Specific models, ratings, & ordering instructions are noted on General Specifications page.

POLES & CIRCUITS

Pole	Model	Rocker Position () = Momentary			Connected Terminals			Throw & Power/Lamp Schematics
		Up	Center	Down	Up	Center	Down	
DP	LW3122 LW3123 LW3125 LW3128 LW3129	ON ON ON (ON) ON	NONE OFF NONE OFF OFF	ON ON (ON) (ON) (ON)	2-3	5-6	OPEN	2-1 5-4

Notes: Terminal numbers are not actually on switch. Lamp circuit is isolated and requires an external power source.

DPDT

LAMP CODES & SPECIFICATIONS

Electrical specifications are determined at a basic temperature of 25°C. Lamp circuit is independent of switch operation.

For dimension drawing of lamps see Accessories & Hardware section.

For neon, if the source voltage is greater than rated voltage, a ballast resistor is required. The ballast resistor calculation and more lamp detail are shown in the Supplement section. Neon not for use with green lamp cover or blue and green filters.

Incandescent & Neon Lamps for Solid & Design Caps

AT602 Incandescent	AT602N Neon	Voltage	V	E	F	H	K	L	N	
				6V AC	12V AC	18V AC	24V AC	28V AC	110V AC	
Current	I	80mA	50mA	35mA	25mA	22mA	1.5mA			
MSCP		.159	.215	.398	.215	.247	NA			
Endurance	Hours	2,000 Average						15,000 Average		
Ambient Temperature Range		-20°C ~ +50°C						-20°C ~ +50°C		
Recommended Resistor for Neon: 33K ohms for 110V AC; 100K ohms for 220V AC										
T-1½ Pilot Slide Base		0		No Lamp Code 0 indicates that no lamp is used.						

ROCKER CAPS, LAMP COVER & FILTER

1 AT420B
White Rocker
without Filters
or Lamp Covers

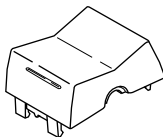

2 AT420B
White Rocker
with Filters

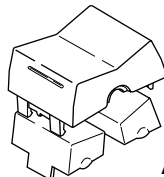

AT421

3 AT420B
White Rocker
with Lamp Covers

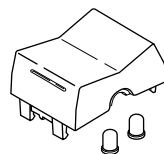

AT416

4 AT420J
Clear Rocker
with Filters

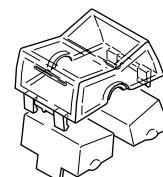

AT421

Rocker Cap Material: Polycarbonate

Finish: Glossy

Indicate the lamp cover or filter color desired in both the up and down positions.

AT416 Lamp Cover

- C** Red
- D** Amber
- F** Green



Material: Silicon Rubber

- B** White
- C** Red
- D** Amber
- E** Yellow
- F** Green
- G** Blue

AT421 Filter

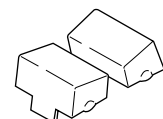

Material: Polycarbonate

BEZEL & BEZEL COLORS

AT206 Bezel & Color Codes

No Code	No Bezel	B	White	D	Amber	F	Green	H	Gray
A	Black	C	Red	E	Yellow	G	Blue		

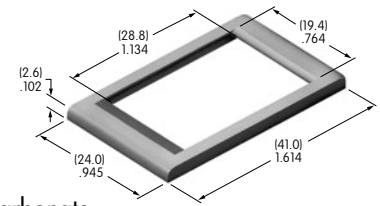

Material: Polycarbonate

TYPICAL SWITCH DIMENSIONS

Solder Lug • Without Bezel

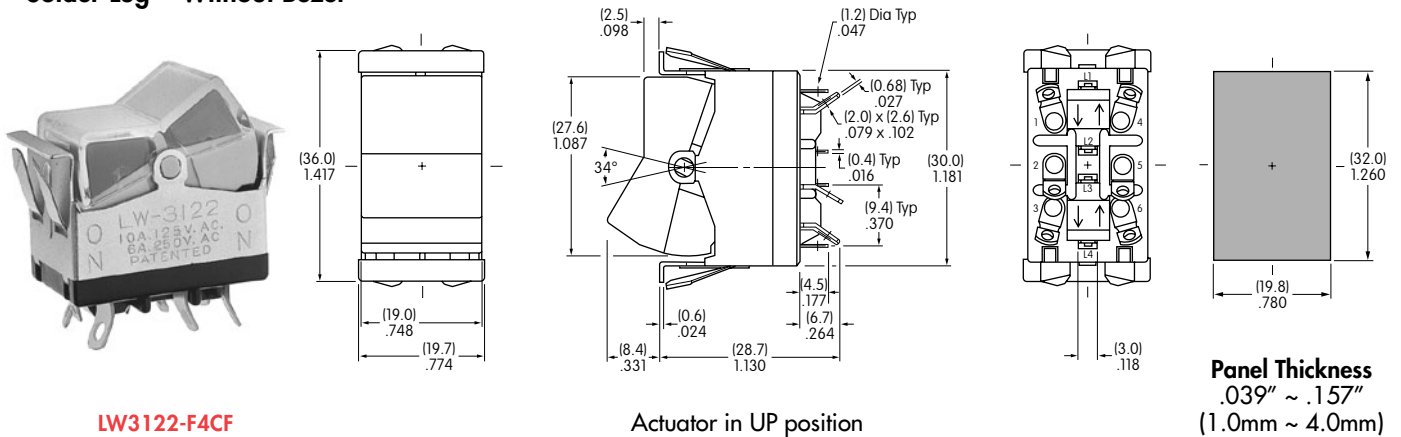

Solder Lug • With Bezel

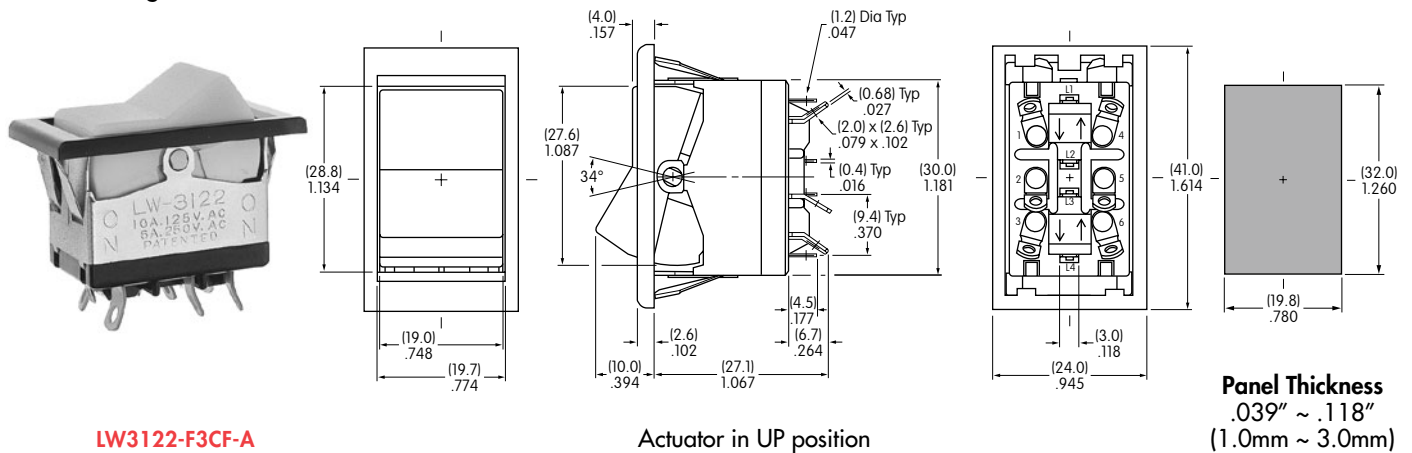

OPTIONAL ACCESSORY

AT107 Lamp Extractor

Lamps can be changed without removing the switch from the panel. AT107 assists in removing lamps from the switch.

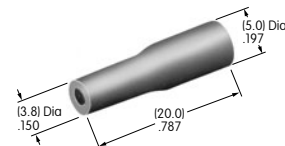

LEGENDS

Inscriptions can be placed on the rocker or filter.
Details regarding screen printing may be obtained from the factory.

Toggles
Rockers
Pushbuttons
Illuminated PB
Programmable
Keylocks
Rotaries
Slides
Tactiles
Tilt
Touch
Indicators
Accessories
Supplement

GENERAL SPECIFICATIONS

Electrical Capacity & Other Ratings

Resistive Load:	20A @ 110V AC
Contact Resistance:	10 milliohms maximum
Insulation Resistance:	1,000 megohms minimum @ 500V DC
Dielectric Strength:	2,000V AC minimum for 1 minute minimum
Mechanical Life:	30,000 operations minimum
Electrical Life:	10,000 operations minimum
Operating Temperature Range:	-10°C through +50°C (+14°F through +122°F)
Nominal Operating Force:	1,250 grams
Angle of Throw:	22°

Materials & Finishes

Rocker:	Polycarbonate resin
Mounting Frame:	Steel with chrome plating
Movable Contacts:	Silver alloy
Stationary Contacts:	Copper with silver plating
Base:	Melamine
Common & End Terminals:	Brass with tin plating

SINGLE POLE HIGH CAPACITY

Model	Pole	Rocker Position			Connected Terminals			Throw & Power/Lamp Schematics
		Up	Center	Down	Up	Center	Down	
								Notes: Terminal numbers are on switch. Lamp circuit is synchronous to switching circuit.
LW3021A	DP	ON	NONE	OFF	1-3 4-6	OPEN	OPEN	DPST

Neon Lamp Specifications

.234" x .198" (5.94mm x 5.03mm) window is translucent red.
Neon lamp with built-in ballast resistor is integral part of switch.

Voltage	V	90 - 120V AC
Internal Series Resistance		100K ohms
Current	I	0.8mA
Endurance		10,000 hours minimum

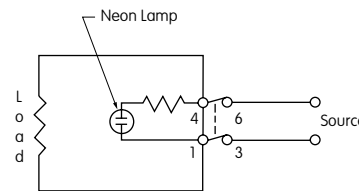

Since this is a double break device, one side of the electrical source should be connected to terminal 3 and the other side to terminal 6. The electrical load should be connected between terminals 1 and 4.

2 screws supplied for flush panel mounting.

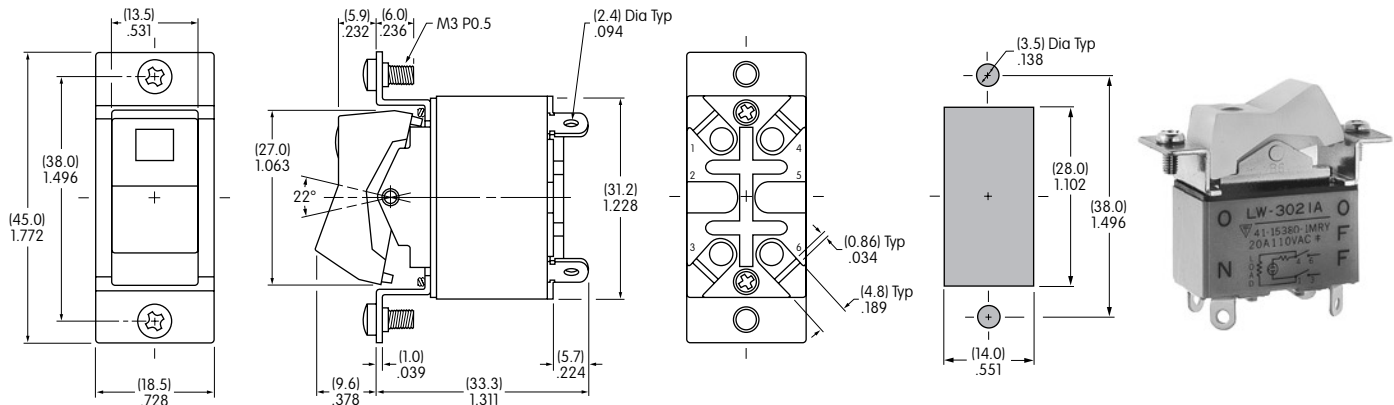

Actuator in UP position

Maximum Panel Thickness:
.197" (5.0mm)

LW3021A

General Specifications

B Electrical Capacity (Resistive Load)

Power Level (silver): 6A @ 125V AC & 3A @ 250V AC
4A @ 30V DC for On-None-On; 3A @ 30V DC for all other circuits

Logic Level (gold): 0.4VA maximum @ 28V AC/DC maximum
(Applicable Range 0.1mA ~ 0.1A @ 20mV ~ 28V)

Logic/Power Level (gold over silver): Combines silver & gold ratings
Note: Find additional explanation of dual rating & operating range in Supplement section.

Other Ratings

Contact Resistance: 10 milliohms maximum for silver; 20 milliohms maximum for gold

Insulation Resistance: 1,000 megohms minimum @ 500V DC

Dielectric Strength: 1,000V AC minimum between contacts for 1 minute minimum;
1,500V AC minimum between contacts and case for 1 minute minimum

Mechanical Life: 50,000 operations minimum

Electrical Life: 25,000 operations minimum for silver; 50,000 operations minimum for gold;
50,000 operations minimum for silver at 3A @ 125V AC

Angle of Throw: 25°

Materials & Finishes

Actuator Clip & Mounting Frame: Stainless Steel

Body Frame: Stainless steel

Case: Diallyl phthalate resin (UL94V-0)

Movable Contactor: Phosphor bronze with silver or gold plating

Movable Contacts: Silver alloy (code W); copper with gold plating (code G); or silver alloy with gold plating (code A)

Stationary Contacts: Silver with silver plating (code W); copper or brass with gold plating (code G);
or silver with gold plating (code A)

Terminals: Copper or brass with silver plating; or copper or brass with gold plating

Environmental Data

Operating Temp Range: -30°C through +85°C (-22°F through +185°F)

Humidity: 90 ~ 95% humidity for 96 hours @ 40°C (104°F)

Vibration: 10 ~ 55Hz with peak-to-peak amplitude of 1.5mm traversing the frequency range & returning
in 1 minute; 3 right angled directions for 2 hours

Shock: 50G (490m/s²) acceleration (tested in 6 right angled directions, with 5 shocks in each direction)

Processing

Soldering: Wave Soldering (PC version) for Gold: See Profile A in Supplement section.

Manual Soldering for Gold: See Profile A in Supplement section.

Wave Soldering (PC version) for Silver: See Profile B in Supplement section.

Manual Soldering for Silver: See Profile B in Supplement section.

Note: Actuator must be in OFF (center) position while soldering.

Cleaning: These devices are not process sealed. Hand clean locally using alcohol based solution.

Standards & Certifications

Flammability Standards: UL94V-0 for case

UL: File No. E44145 - Recognized only when ordered with marking on switch.

Add "/U" before first dash in part number to order UL recognized switch.

All models recognized at 6A @ 125V AC, 3A @ 250V AC or 0.4VA maximum @ 28V DC maximum.

CSA: File No. 023535_0_000 - Certified only when ordered with marking on switch.

Add "/C" before first dash in part number to order CSA certified switch.

All models certified at 6A @ 125V AC or 3A @ 250V AC or 0.4VA maximum @ 28V maximum.

Distinctive Characteristics

Three methods of panel mounting: flat frame for flush with face or subpanel, snap-in, and PCB.

High insulating barriers increase isolation of circuits in multipole devices and provide added protection to contact points.

The molded diallyl phthalate case has a UL 94V-0 flammability rating.

Epoxy sealed terminals prevent entry of solder flux and other contaminants.

Prominent external insulating barriers increase insulation resistance and dielectric strength.

Bias guard prevents misalignment of contacts; interlocking of actuator block with rocker and internal guide does not allow transmission of diagonal force on rocker to reach contact mechanism.

Clinching of the frame to the case well above the base and terminals provides 1,500V dielectric strength.

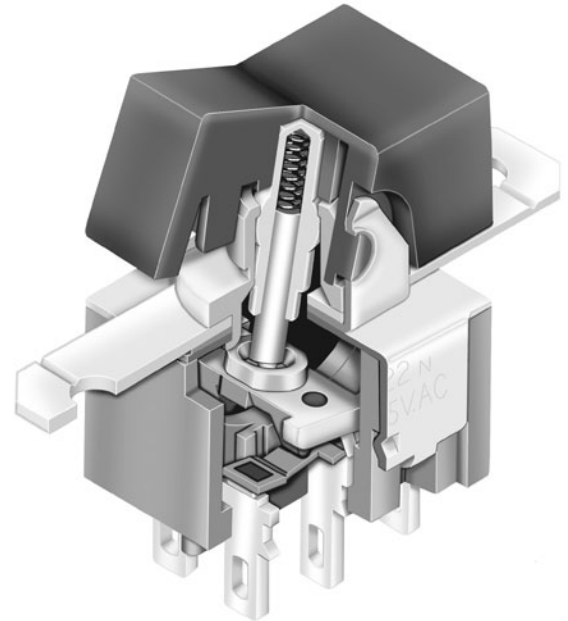

Actual Size

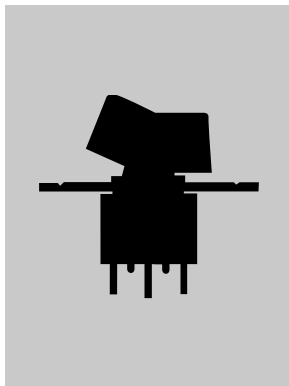

- Toggle
- B** Rockers
- Pushbuttons
- Illuminated PB
- Programmable
- Keylocks
- Rotaries
- Slides
- Tactiles
- Tilt
- Touch
- Indicators
- Accessories
- Supplement

TYPICAL SWITCH

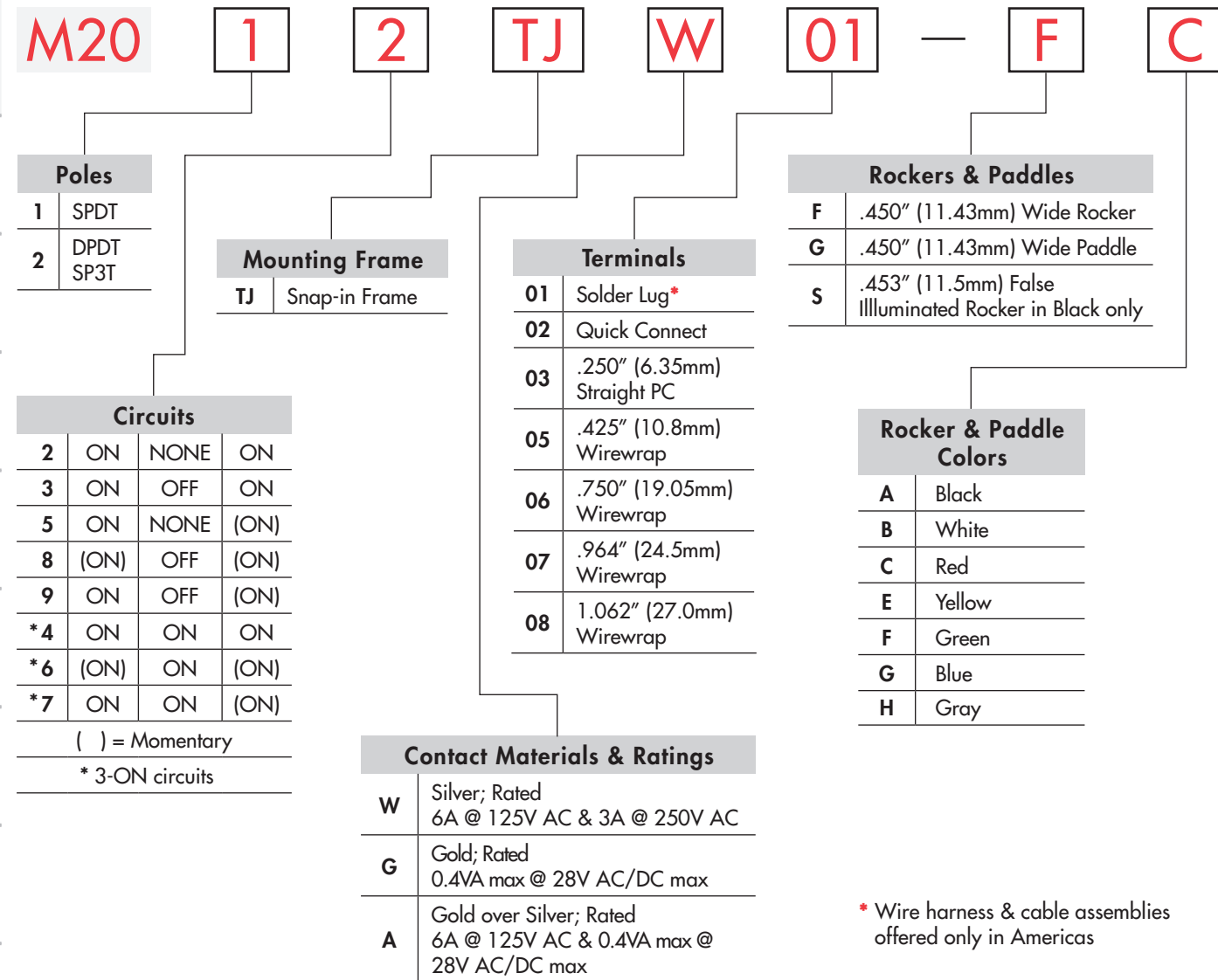

DESCRIPTION FOR TYPICAL ORDERING EXAMPLE

M2012TJW01-FC-1A

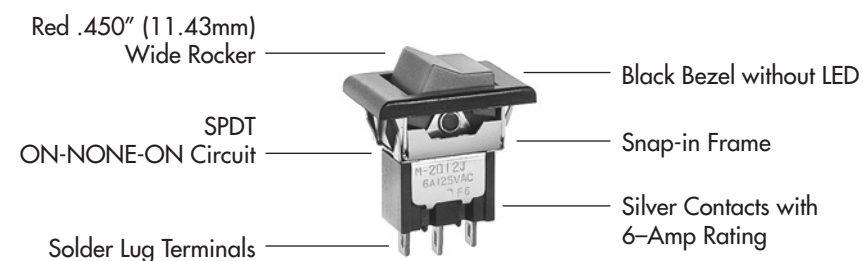

ORDERING EXAMPLE

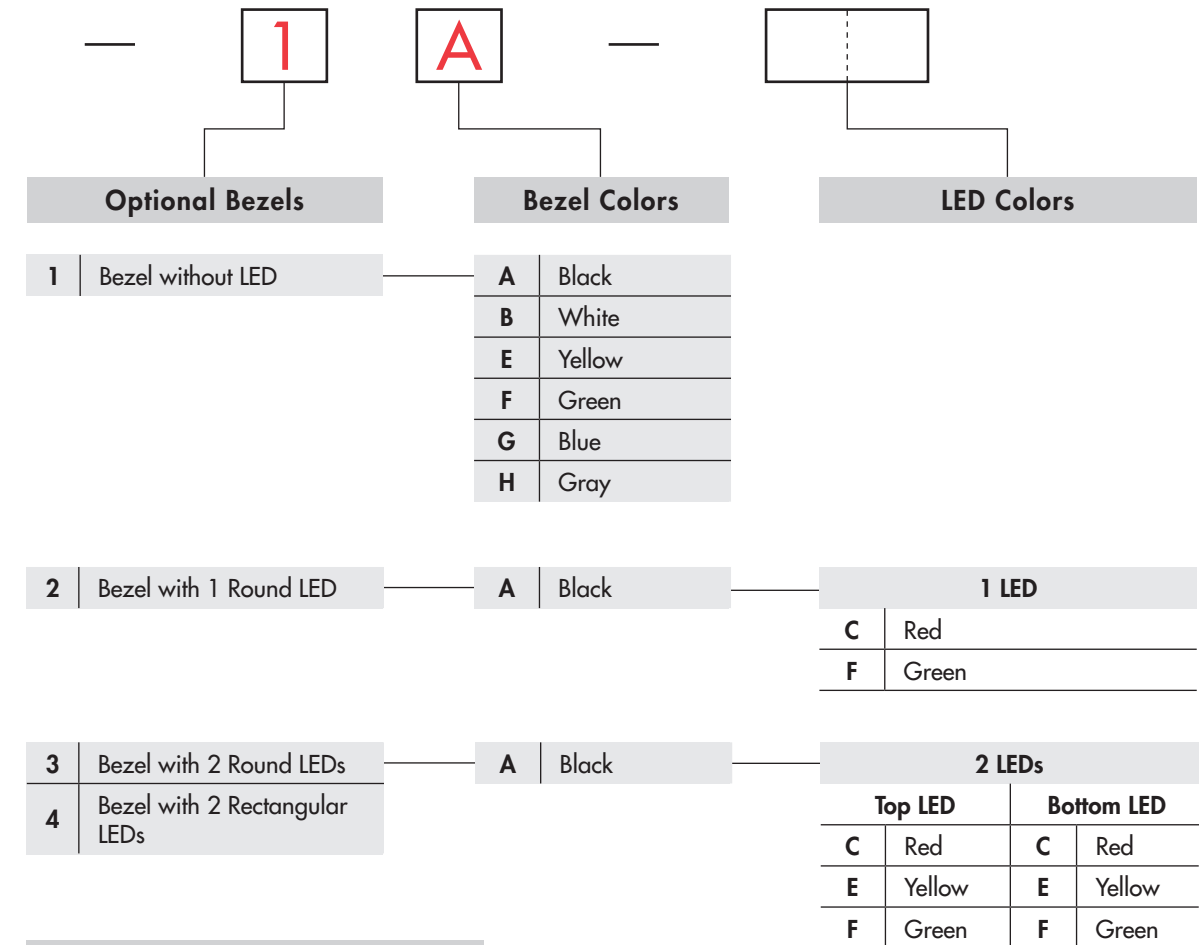

IMPORTANT:
Switches are supplied without UL & CSA marking unless specified. **UL & CSA recognized only when ordered with marking on the switch.** Specific models, ratings, & ordering instructions are noted on General Specifications page.

DESCRIPTION FOR TYPICAL ORDERING EXAMPLE

M2012TJW01-FC-3A-CF

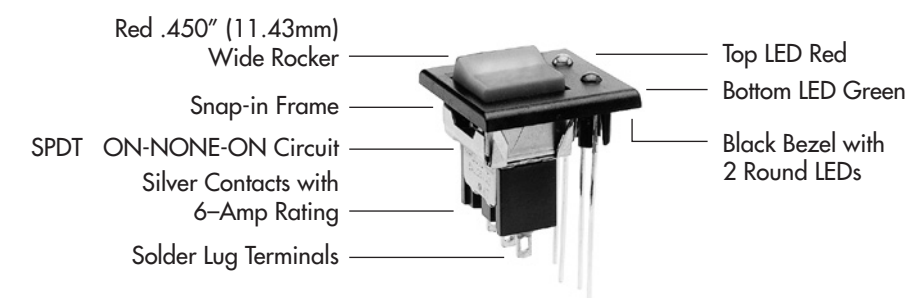

Toggle

Rockers **B**

Pushbuttons

Programmable Illuminated PB

Keylocks

Rotaries

Slides

Tactiles

Tilt

Touch

Indicators

Accessories

Supplement

POLES & CIRCUITS

		Rocker Position () = Momentary			Connected Terminals			Throw & Schematics
Pole	Model	Down	Center	Up	Down	Center	Up	
SP	M2012 M2013 M2015 M2018 M2019	ON ON ON (ON) ON	NONE OFF NONE OFF OFF	ON ON (ON) (ON) (ON)	2-3	OPEN	2-1	Note: Terminal numbers are not actually on the switch. SPDT
DP	M2022 M2023 M2025 M2028 M2029	ON ON ON (ON) ON	NONE OFF NONE OFF OFF	ON ON (ON) (ON) (ON)	2-3 5-6	OPEN	2-1 5-4	DPDT

For 3 Throw (3-On)

		Connected Terminals & Schematic			External Connection
Pole	Model	Down	Center	Up	
SP	M2024 M2026 M2027	ON (ON) ON 2-3 5-6	ON ON ON 2-3 5-4	ON (ON) (ON) 2-1 5-4	The SP3T model utilizes a double pole base. External connection must be made during field installation.

MOUNTING FRAME

TJ

Snap-in Frame

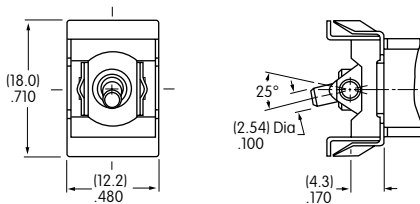

Panel Cutout for Single Pole without Bezel

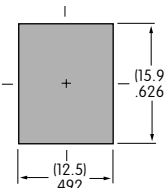

Panel Cutout for Double Pole without Bezel

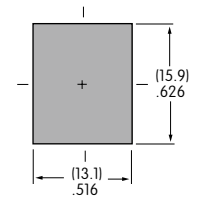

Panel Thickness without Bezel: .039" ~ .126" (1.0mm ~ 3.2mm)
Panel Thickness with Bezel: .039" ~ .098" (1.0mm ~ 2.5mm)

CONTACT MATERIALS & RATINGS

W

Silver over Silver

Power Level

6A @ 125V AC & 3A @ 250V AC

G

Gold over Brass or Copper

Logic Level

0.4VA maximum @ 28V AC/DC maximum

Note: See Supplement section to find complete explanation of operating range.

A

Gold over Silver

Power Level
or Logic Level

6A @ 125V AC
or 0.4VA maximum @ 28V AC/DC maximum

Note: This dual rated option is suitable when two or more identical switches are used in logic and in power circuits within the same application. See Supplement section to find complete explanation of dual rating and operating range.

TERMINALS

01 Solder Lug

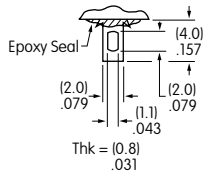

02 .062" (1.57mm) Wide Quick Connect

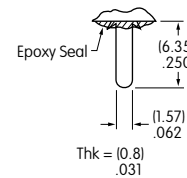

03 .250" (6.35mm) Straight PC

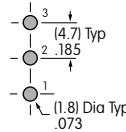
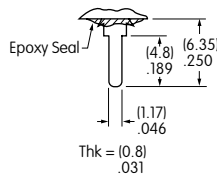

Single Pole

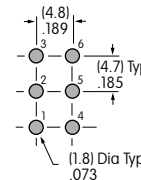

Double Pole

05 .425" (10.8mm) Wirewrap or Extended PC

06 .750" (19.05mm) Wirewrap or Extended PC

07 .964" (24.5mm) Wirewrap or Extended PC

08 1.062" (27.0mm) Wirewrap or Extended PC

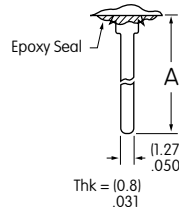

If using as extended PC terminal, refer to the above footprints.

Dimension A = terminal lengths as shown beside the terminal codes at the left.

ROCKERS & PADDLES

F AT4150
.450" (11.43mm)
Wide Rocker

Material: Polyamide
Finish: Matte

Colors Available:
A, B, C, E, F, G, H

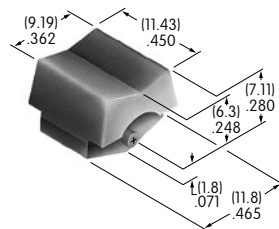

G AT4151
.450" (11.43mm)
Wide Paddle

Material: Polyamide
Finish: Matte

Colors Available:
A, B, C, E, F, G, H

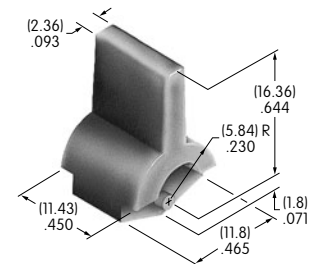

S AT466 .453" (11.5mm)
False Illuminated Rocker

	<u>Rocker</u>	<u>False Illuminator</u>
Material:	Polycarbonate	Acrylonitrile Butadiene Styrene
Finish:	Glossy	
Colors:	Black	White and Red

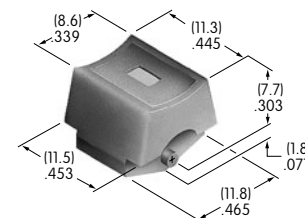

When a bezel is selected with AT466, glossy polycarbonate AT207 is supplied.

Cap Colors Available: **A** Black **B** White **C** Red **E** Yellow **F** Green **G** Blue **H** Gray

OPTIONAL SNAP-IN BEZELS & BEZEL COLORS

1 AT2107 Bezel

Material: Polyamide

Finish: Matte

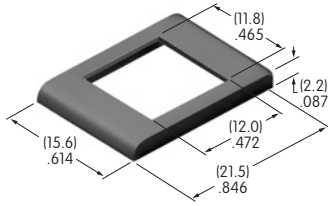

A Black

B White

E Yellow

F Green

G Blue

H Gray

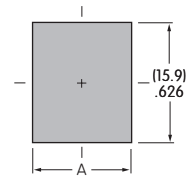

	Single Pole	Double Pole
A	(12.5)mm .492"	(13.1)mm .516"

2 AT208 Bezel for AT070 LED

Material: Polycarbonate

Finish: Glossy

Contact factory for matte finish.

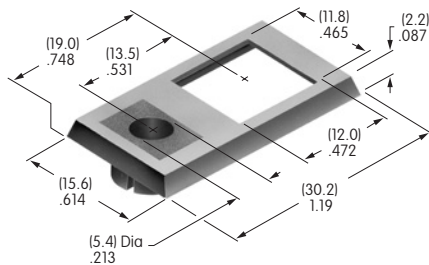

A Black

LED colors & specifications on next page.

	Single Pole	Double Pole
A	(12.5)mm .492"	(13.1)mm .516"
B	(6.25)mm .246"	(6.55)mm .258"

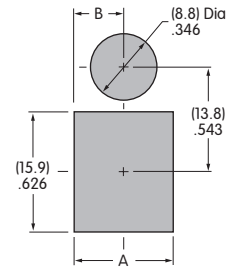

3 AT212 Bezel for AT617 LED

Material: Polycarbonate

Finish: Semi-glossy

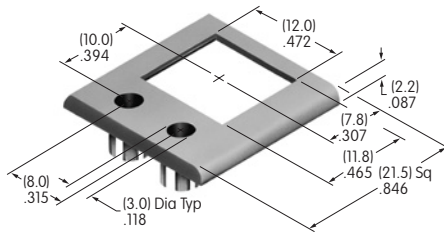

A Black

LED colors & specifications on next page.

	Single Pole	Double Pole
A	(18.4)mm .724"	(18.7)mm .736"

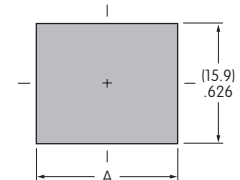

4 AT213 Bezel for AT618 LED

Material: Polycarbonate

Finish: Semi-glossy

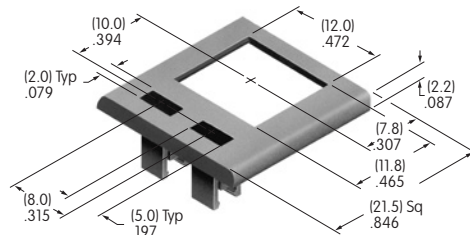

A Black

LED colors & specifications on next page.

	Single Pole	Double Pole
A	(18.4)mm .724"	(18.7)mm .736"

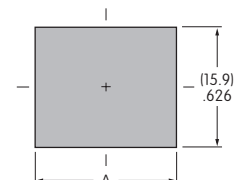

Bezel Assembly

1. Pry out tab on bezel to a 45° angle.

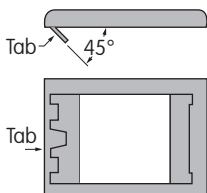

2. Insert switch frame under tab and snap on bezel.

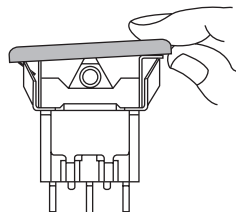

3. Push tab back into place.

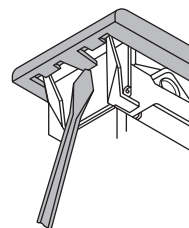

4. Snap assembled bezel and switch into panel.

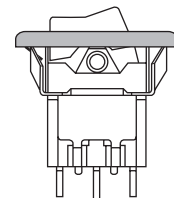

LED COLORS & SPECIFICATIONS

Bezel Orientation on Switch

AT070 LED
For Bezel AT208
with 1 LED

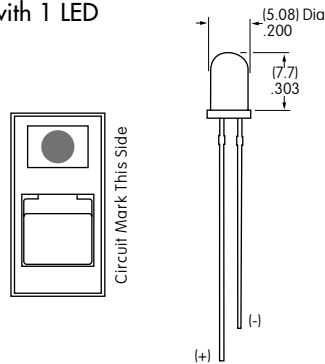

AT617 LED
For Bezel AT212
with 2 Round LEDs

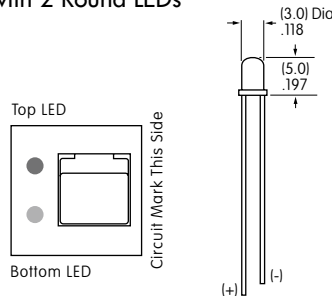

AT618 LED
For Bezel AT213
with 2 Rectangular LEDs

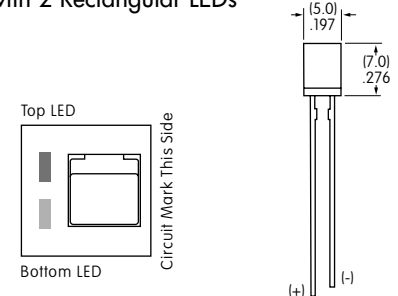

Note: Lead lengths may differ from manufacturing lot to lot. The longer lead is the anode (+).

	Color	AT070		AT617			AT618		
		C	F	C	E	F	C	E	F
		Red	Green	Red	Yellow	Green	Red	Yellow	Green
Forward Peak Current	I_{FM}	25mA	50mA	30mA	30mA	25mA	10mA	30mA	30mA
Typical Forward Current	I_F	20mA	30mA	20mA	20mA	20mA	8mA	24mA	24mA
Forward Voltage	V_F	2.8V	2.1V	2.0V	2.1V	2.2V	1.9V	2.0V	2.1V
Reverse Peak Voltage	V_{RM}	4V	5V	5V	5V	5V	5V	5V	5V
Current Reduction Rate Above 25°C	ΔI_F	0.33 mA/°C	0.40 mA/°C	0.40 mA/°C	0.40 mA/°C	0.33 mA/°C	0.13 mA/°C	0.40 mA/°C	0.40 mA/°C
Ambient Temperature Range (when used with a bezel)		-10° ~ +70°C		-15° ~ +70°C			-15° ~ +70°C		

The electrical specifications shown are determined at a basic temperature of 25°C. LED circuit is independent of switch operation. LED is colored in OFF state.

If the source voltage is greater than the rated voltage of the LED, a ballast resistor must be connected in series with the lamp. The ballast resistor calculation and more lamp detail are shown in the Supplement section.

LEGENDS

NKK Switches can provide custom legends for caps. Contact factory for more information.

Suggested Printable Area for Cap

Recommended Print Method:

Pad Print

Epoxy based ink is recommended.



AT4150

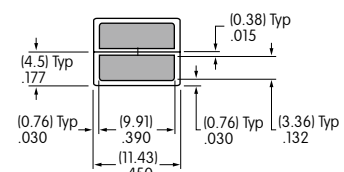

Shaded areas are printable areas.

TYPICAL SWITCH DIMENSIONS

Snap-in Frame • Solder Lug

Single Pole

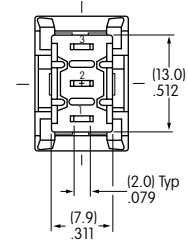
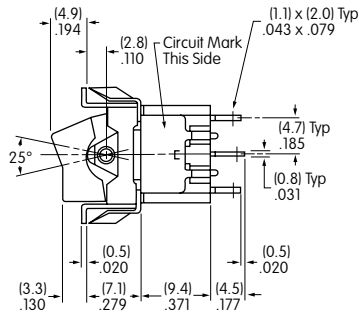
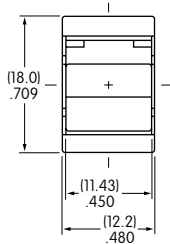

M2012TJW01-FC

Snap-in Frame • Solder Lug

Double Pole

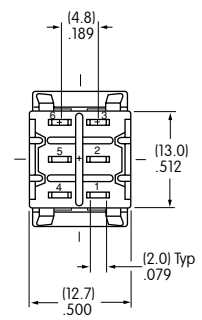
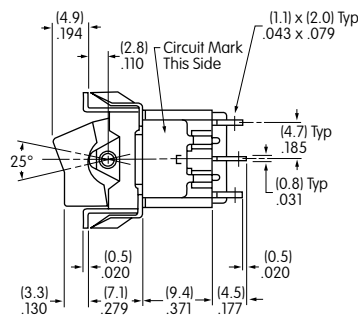
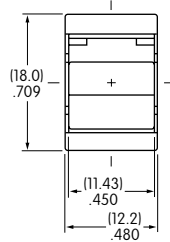

M2022TJW01-FC

Snap-in Frame • Solder Lug

Single Pole

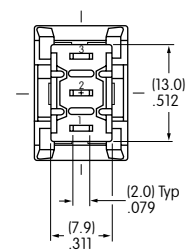
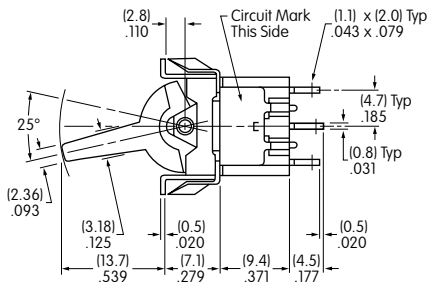
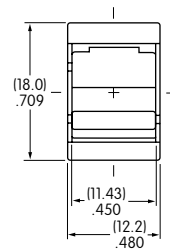

M2012TJW01-GC

Snap-in Frame • Solder Lug

Double Pole

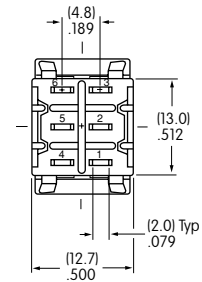
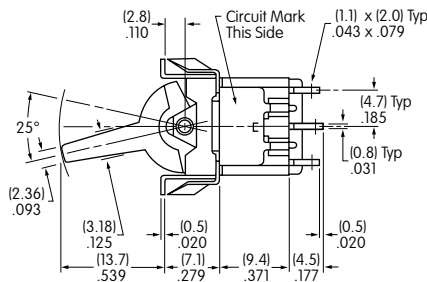
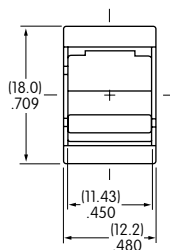

M2022TJW01-GC

TYPICAL SWITCH DIMENSIONS

Single & Double Pole

Snap-in Frame • AT2107 Bezel • Solder Lug

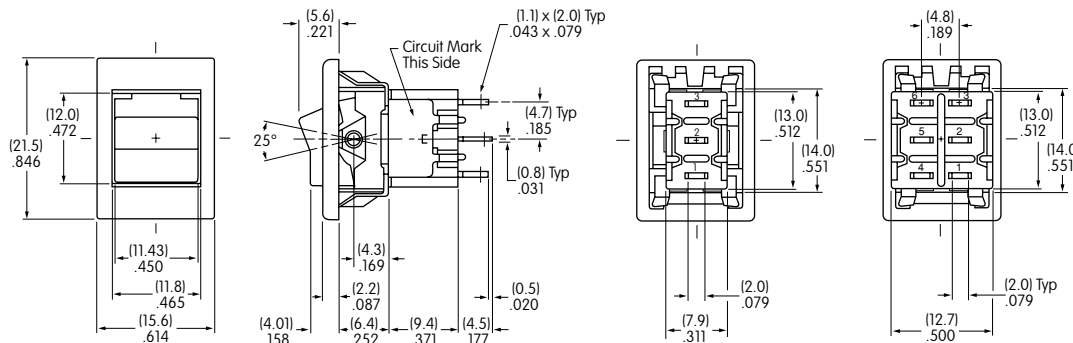

M2012JW01-FC-1A

Double Pole

Snap-in Frame • AT208 Bezel • Solder Lug

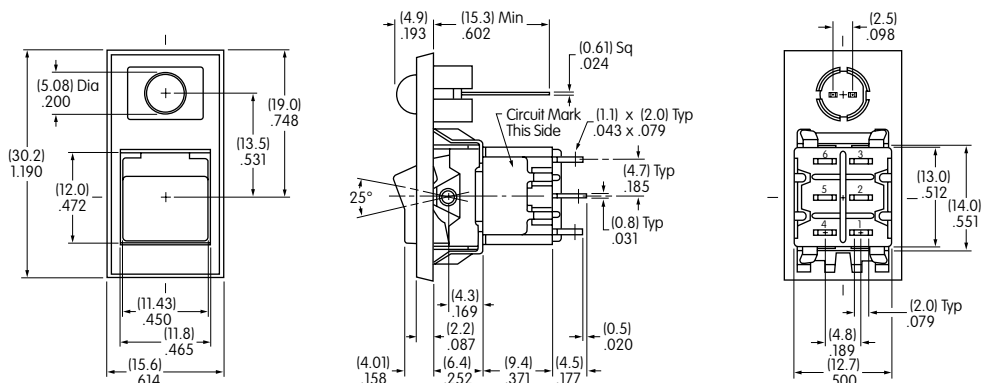

M2022JW01-FC-2A-C

Single Pole

Snap-in Frame • AT212 Bezel • Solder Lug

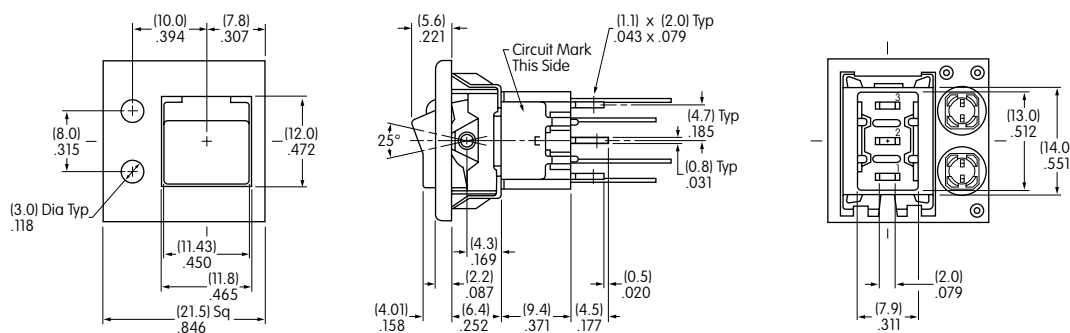

M2012JW01-FC-3A-CF

Double Pole

Snap-in Frame • AT213 Bezel • Solder Lug

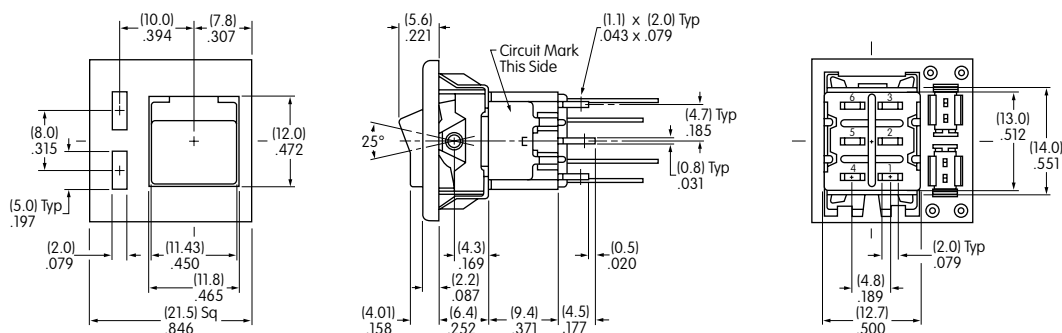

M2022JW01-FC-4A-CF

Toggles

B Rockers

Pushbuttons

Illuminated PB

Programmable

Keylocks

Rotaries

Slides

Tactiles

Tilt

Touch

Indicators

Accessories

Supplement

TYPICAL SWITCH

ORDERING EXAMPLE

M20 **1** **3** **TX** **G**

Poles	
1	SPDT
2	DPDT SP3T
3	3PDT (used only with terminal codes 30 & 41 & frame code TX)
4	4PDT DP3T (used only with terminal code 41 & frame code TX)

Mounting Frames	
TX	Narrow Frame for Small Actuator
TZ	Wide Frame for Large Actuator

Circuits			
2	ON	NONE	ON
3	ON	OFF	ON
5	ON	NONE	(ON)
8	(ON)	OFF	(ON)
9	ON	OFF	(ON)
*4	ON	ON	ON
*6	(ON)	ON	(ON)
*7	ON	ON	(ON)

() = Momentary
* 3-ON circuits

Contact Materials & Ratings	
W	Silver; Rated 6A @ 125V AC & 3A @ 250V AC
G	Gold; Rated 0.4VA max @ 28V AC/DC max
A	Gold over Silver; Rated 6A @ 125V AC & 0.4VA max @ 28V AC/DC max

41 — **D** **C**

Terminals For TX & TZ Frames	
Straight PC with Bracket (1-2 Pole only)	
13	.250" (6.35mm) Straight PC with .465" (11.8mm) Bracket
15	.425" (10.8mm) Straight PC with .630" (16.0mm) Bracket
17	.964" (24.5mm) Straight PC with 1.150" (29.2mm) Bracket
Straight PC with Reinforced Bracket (1-2 Pole only)	
23	.250" (6.35mm) Straight PC with .465" (11.8mm) Bracket
25	.425" (10.8mm) Straight PC with .630" (16.0mm) Bracket
26	.750" (19.05mm) Straight PC with .953" (24.2mm) Bracket
Terminals For TX Frame Only	
Right Angle PC with Support (1-3 Pole only)	
30	.150" (3.81mm) Right Angle PC
Vertical PC with Support (1-4 Pole)	
41	.150" (3.81mm) Vertical PC

Rockers & Paddles	
Small Actuators (TX Frame)	
D	.365" (9.27mm) Wide Rocker
E	.365" (9.27mm) Wide Paddle
F	.450" (11.43mm) Wide Rocker
G	.450" (11.43mm) Wide Paddle
Large Actuators (TZ Frame)	
J	.595" (15.11mm) Wide Rocker
H	.595" (15.11mm) Wide Paddle

Rocker & Paddle Colors	
A	Black
B	White
C	Red
E	Yellow
F	Green
G	Blue
H	Gray

IMPORTANT:
Switches are supplied without UL & CSA marking unless specified. **UL & CSA recognized only when ordered with marking on the switch.** Specific models, ratings, & ordering instructions are noted on General Specifications page.

DESCRIPTION FOR TYPICAL ORDERING EXAMPLE

M2013TXG41-DC

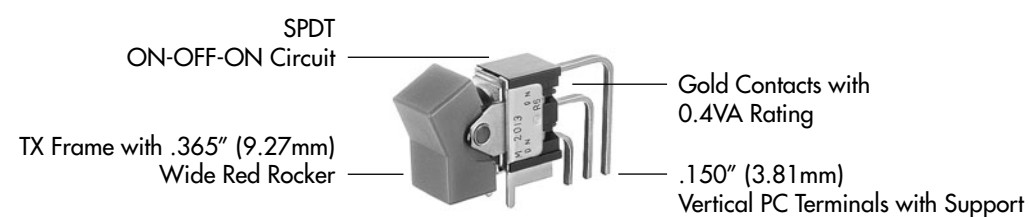

DESCRIPTION FOR TYPICAL ORDERING EXAMPLE

M2022TZG23-JC

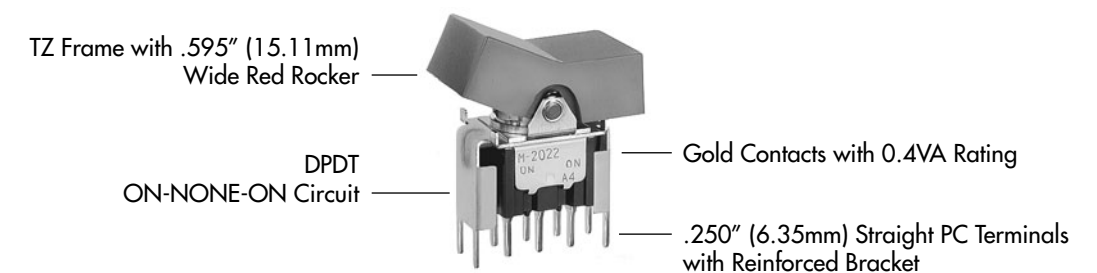

POLES & CIRCUITS

Pole	Model	Rocker Position () = Momentary			Connected Terminals			Throw & Schematics
		Down	Center	Up	Down	Center	Up	
SP	M2012 M2013 *M2015 M2018 *M2019	ON ON ON (ON) ON	NONE OFF NONE OFF OFF	ON ON (ON) (ON) (ON)	2-3	OPEN	2-1	Note: Terminal numbers are not actually on the switch. * Reverse circuits available for vertical mount SP & DP upon request. SPDT
DP	M2022 M2023 *M2025 M2028 *M2029	ON ON ON (ON) ON	NONE OFF NONE OFF OFF	ON ON (ON) (ON) (ON)	2-3 5-6	OPEN	2-1 5-4	DPDT
3P	M2022 M2023 *M2025 M2028 *M2029	ON ON ON (ON) ON	NONE OFF NONE OFF OFF	ON ON (ON) (ON) (ON)	2-3 5-6 8-9	OPEN	2-1 5-4 8-7	3PDT
4P	M2042 M2043 *M2045 M2048 *M2049	ON ON ON (ON) ON	NONE OFF NONE OFF OFF	ON ON (ON) (ON) (ON)	2-3 5-6 8-9 11-12	OPEN	2-1 5-4 8-7 11-10	4PDT

For 3 Throw (3-On)

Connected Terminals & Schematics

Pole	Model	Down	Center	Up	Down	Center	Up
SP	M2024 M2026 M2027	ON (ON) ON	ON ON ON	ON (ON) (ON)			
DP	M2044 M2046 M2047	ON (ON) ON	ON ON ON	ON (ON) (ON)			

The SP3T model utilizes a double pole base.

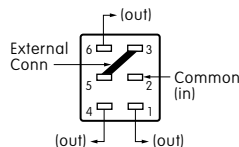

External connection must be made during field installation.

The DP3T model utilizes a four pole base.

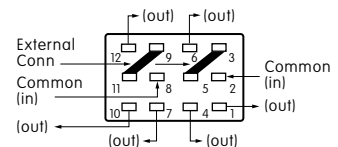

External connection must be made during field installation.

MOUNTING FRAMES

TX Narrow Mounting Frame for Small Actuators with Straight PC Terminals (codes 13, 15, 17, 23, 25, & 26) or with Angle PC Terminals (codes 30 & 41)

Straight PC Mounting

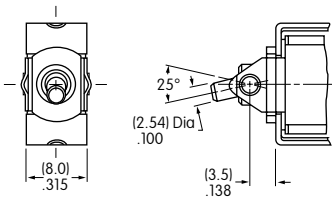

Right Angle PC Mounting

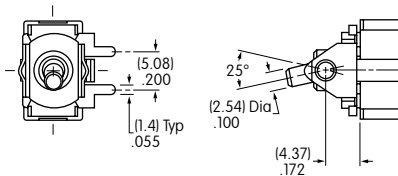

Vertical PC Mounting

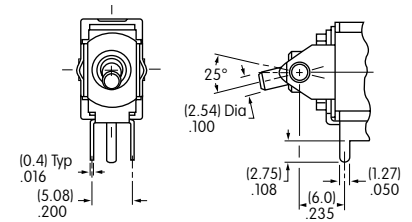

Small Actuators & Panel Cutouts for TX Frame (actuator details on the following pages)

AT4148

AT4149

AT4150

AT4151

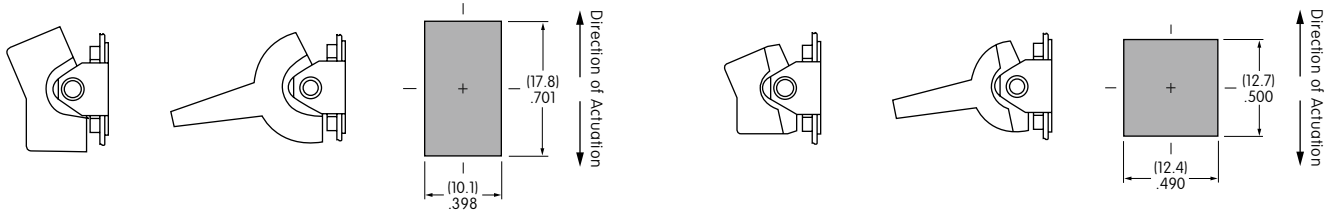

TZ Wide Mounting Frame for Large Actuators with Straight PC Terminals (codes 13, 15, 17, 23, 25, & 26)

Large Actuators & Panel Cutouts for TZ Frame (actuator details on the following pages)

AT4156

AT4157

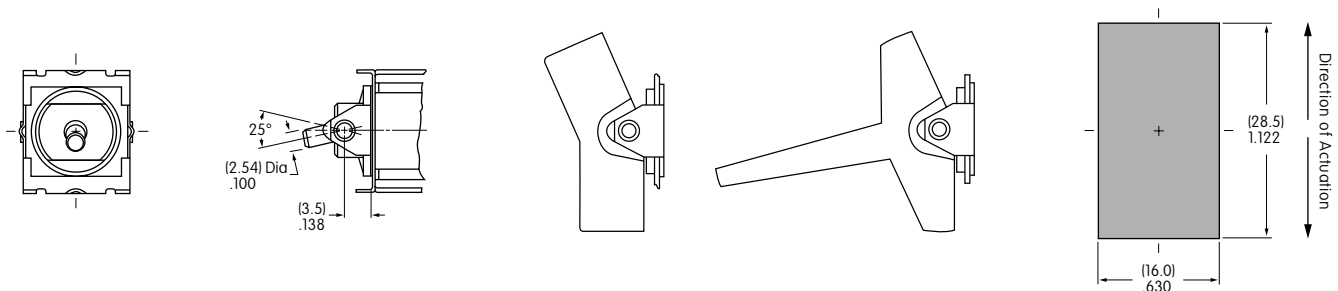

CONTACT MATERIALS & RATINGS

W Silver over Silver **Power Level** 6A @ 125V AC & 3A @ 250V AC

G Gold over Brass or Copper **Logic Level** 0.4VA maximum @ 28V AC/DC maximum

Note: See Supplement section to find complete explanation of operating range.

A Gold over Silver **Power Level or Logic Level** 6A @ 125V AC or 0.4VA maximum @ 28V AC/DC maximum

Note: This dual rated option is suitable when two or more identical switches are used in logic and in power circuits within the same application. See Supplement section to find complete explanation of dual rating and operating range.

Toggle

Rockers **B**

Pushbuttons

Programmable Illuminated PB

Keylocks

Rotaries

Slides

Tactiles

Tilt

Touch

Indicators

Accessories

Supplement

TERMINALS

For TX and TZ 1-2 Pole
Straight PC Mount with Bracket

For TX and TZ 1-2 Pole
Straight PC Mount with Reinforced Bracket

13

.250" (6.35mm)
Terminal with
.465" (11.8mm)
Bracket

15

.425" (10.8mm)
Terminal with
.630" (16.0mm)
Bracket

17

.964" (24.5mm)
Terminal with
1.150" (29.2mm)
Bracket

23

.250" (6.35mm)
Terminal with
.465" (11.8mm)
Bracket

25

.425" (10.8mm)
Terminal with
.630" (16.0mm)
Bracket

26

.750" (19.05mm)
Terminal with
.953" (24.2mm)
Bracket

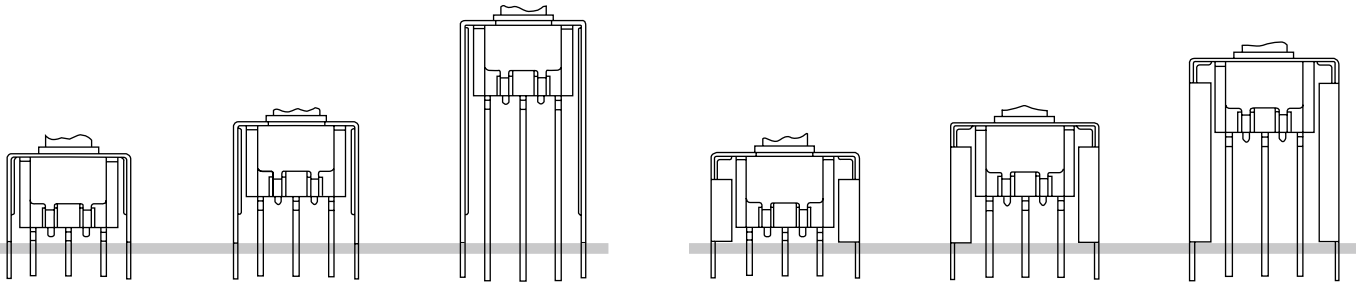

PCB footprints are on the following Typical Switch Dimension pages.

For TX 1-3 Pole Right Angle PC Mount

For TX 1-4 Pole Vertical PC Mount

30

.150" (3.81mm)
Right Angle PC



41

.150" (3.81mm)
Vertical PC

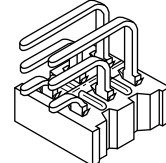

ROCKERS & PADDLES FOR TX MOUNTING FRAMES

D

AT4148 .365" (9.27mm)
Wide Rocker

Material: Polyamide
Finish: Matte



E

AT4149 .365" (9.27mm)
Wide Paddle

Material: Polyamide
Finish: Matte

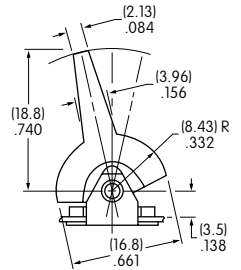

F

AT4150 .450" (11.43mm)
Wide Rocker

Material: Polyamide
Finish: Matte



G

AT4151 .450" (11.43mm)
Wide Paddle

Material: Polyamide
Finish: Matte

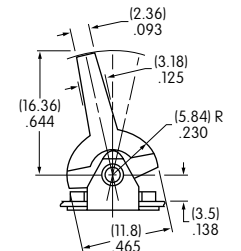

Cap Colors
Available:

A

Black

B

White

C

Red

E

Yellow

F

Green

G

Blue

H

Gray

ROCKERS & PADDLES FOR TZ MOUNTING FRAMES

J AT4156 .595" (15.11mm)
Wide Rocker

Material: Polyamide
Finish: Matte

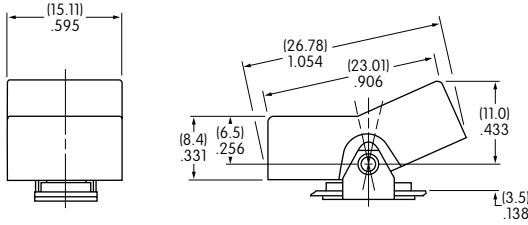
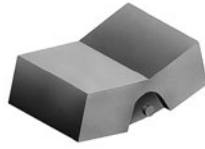

H AT4157 .595" (15.11mm)
Wide Paddle

Material: Polyamide
Finish: Matte

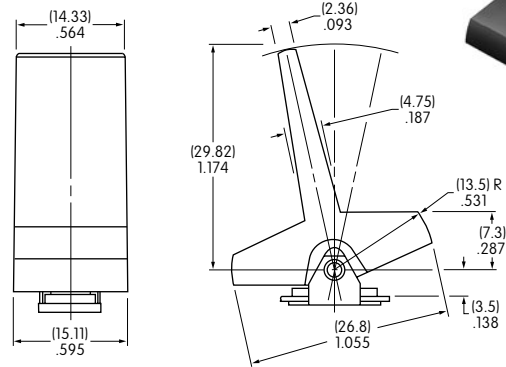

Cap Colors Available:



Black



White



Red



Yellow



Green



Blue



Gray

OPTIONAL SNAP-IN PANEL FRAMES

Used with AT4148 Rocker and AT4149 Paddle

AT064-1

Accommodates .047" ~ .090"
(1.2 ~ 2.3mm) panel thickness

Material: Polyamide
Finish: Matte
Color: Black

Mounted separately from switches

Cutout Tolerances:

Dimension A:
.797" ~ .803" (20.24 ~ 20.4mm)

Dimension B:
.495" ~ .505" (12.57 ~ 12.83mm)



AT064-2

Accommodates .062" ~ .125"
(1.57 ~ 3.18mm) panel thickness

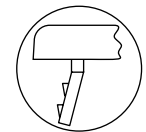
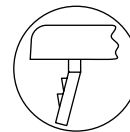
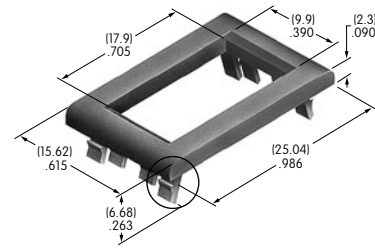

AT064-1 Enlarged Detail

Used with AT4150 Rocker and AT4151 Paddle

AT065-1

Accommodates .047" ~ .090"
(1.2 ~ 2.3mm) panel thickness

Material: Polyamide
Finish: Matte
Color: Black

Mounted separately from switches

Cutout Tolerances:

Dimension A:
.595" ~ .605" (15.11 ~ 15.37mm)

Dimension B:
.495" ~ .500" (12.57 ~ 12.7mm)



AT065-2

Accommodates .062" ~ .125"
(1.57 ~ 3.18mm) panel thickness

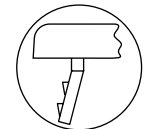
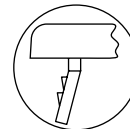
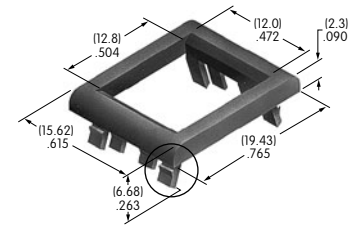

AT065-1 Enlarged Detail

AT065-2 Enlarged Detail

TYPICAL SWITCH DIMENSIONS

Straight PC • Bracket

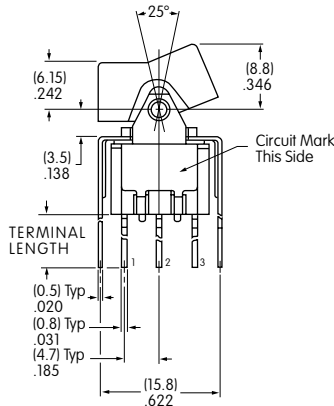

M2012TXG13-DC

Terminal Code:	Terminal Length:	Bracket Length:
13	.250" (6.35mm)	.465" (11.8mm)
15	.425" (10.8mm)	.630" (16.0mm)
17	.964" (24.5mm)	1.150" (29.2mm)



Straight PC • Reinforced Bracket

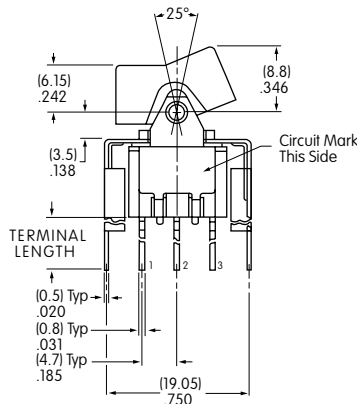

M2012TXG23-DC

Terminal Code:	Terminal Length:	Bracket Length:
23	.250" (6.35mm)	.465" (11.8mm)
25	.425" (10.8mm)	.630" (16.0mm)
26	.750" (19.05mm)	.953" (24.2mm)



TYPICAL SWITCH DIMENSIONS

Single Pole

.150" (3.81 mm) Right Angle PC

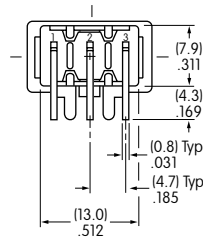

M2012TXG30-DC

Double Pole

.150" (3.81 mm) Right Angle PC

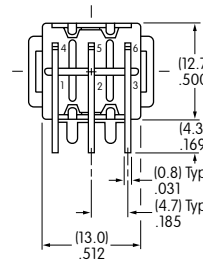
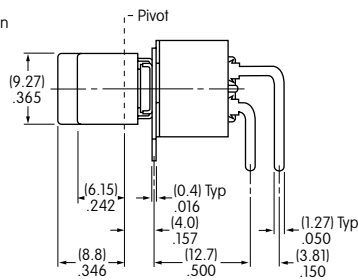

M2022TXG30-DC

Three Pole

.150" (3.81 mm) Right Angle PC

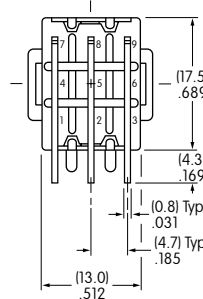

M2032TXG30-DC

TYPICAL SWITCH DIMENSIONS

.150" (3.81mm) Vertical PC

Single Pole

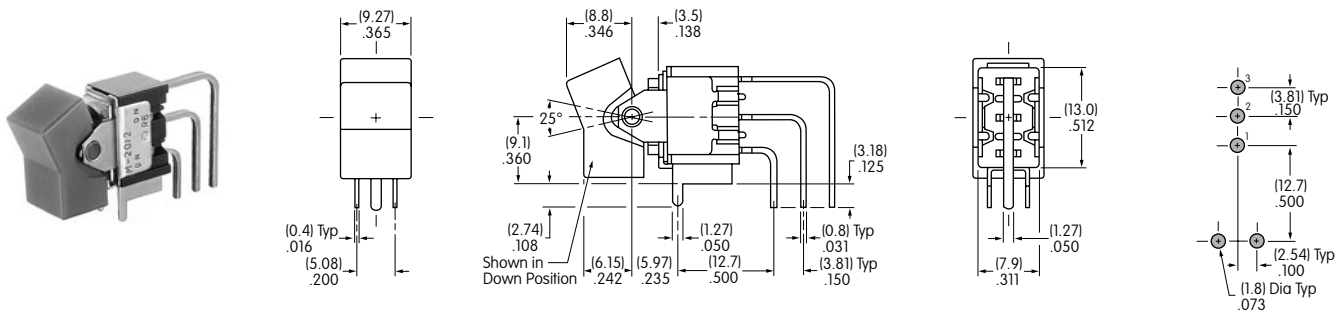

M2012TXG41-DC

.150" (3.81mm) Vertical PC

Double Pole

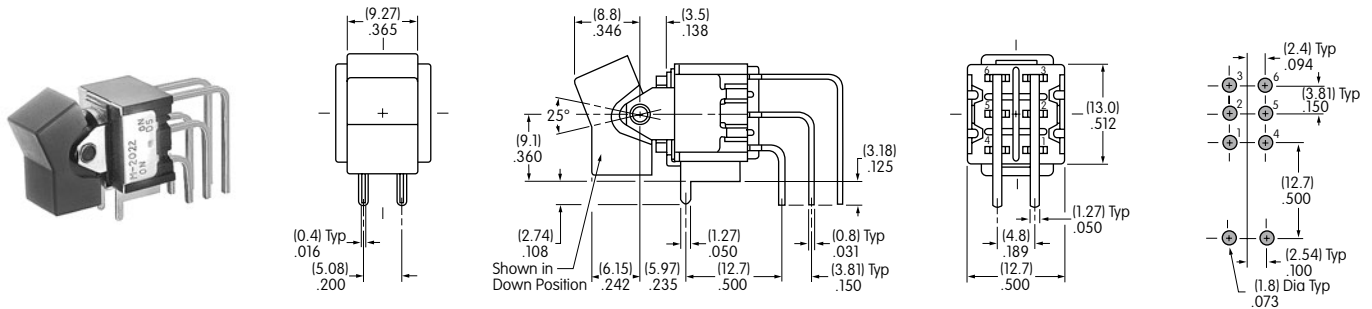

M2022TXG41-DC

.150" (3.81mm) Vertical PC

Three Pole



M2032TXG41-DC

.150" (3.81mm) Vertical PC

Four Pole

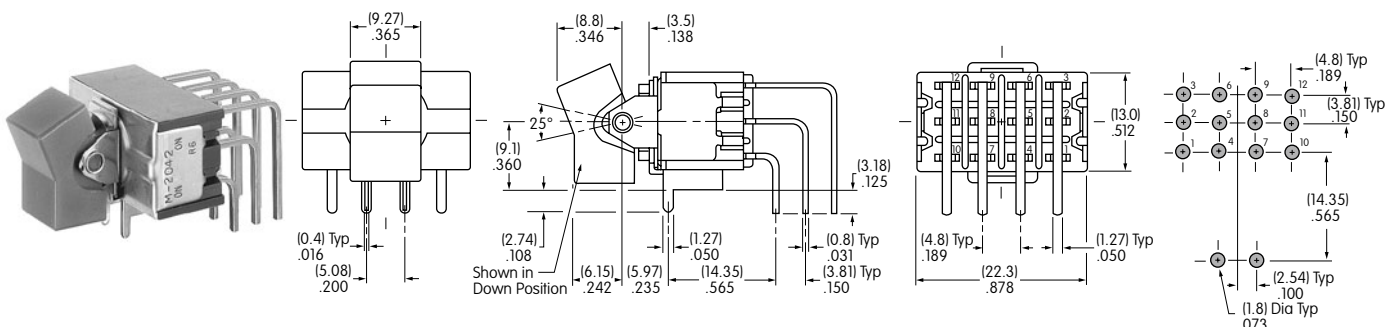

M2042TXG41-DC

Toggles

Rockers **B**

Pushbuttons

Illuminated PB

Programmable

Keylocks

Rotaries

Slides

Tactiles

Tilt

Touch

Indicators

Accessories

Supplement

TYPICAL SWITCH DIMENSIONS

Straight PC • Bracket

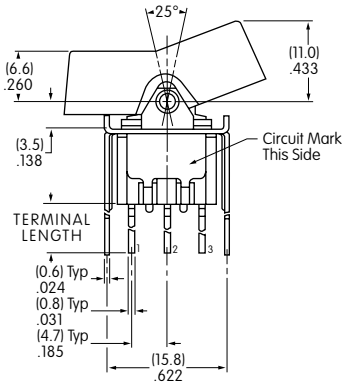

Single Pole

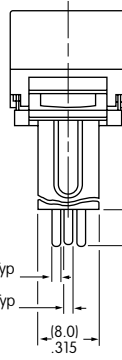

Double Pole

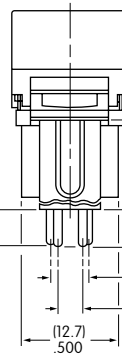

M2012ZG13-JC



Terminal Code:	Terminal Length:	Bracket Length:
13	.250" (6.35mm)	.465" (11.8mm)
15	.425" (10.8mm)	.630" (16.0mm)
17	.964" (24.5mm)	1.150" (29.2mm)

Straight PC • Reinforced Bracket

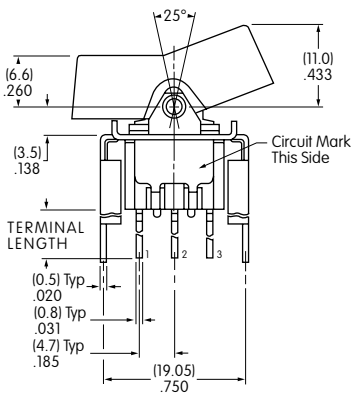

Single Pole

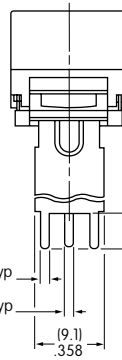

Double Pole

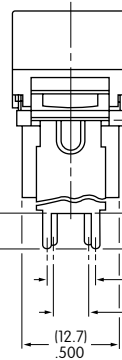

M2012ZG23-JC

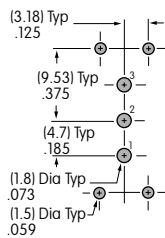

Terminal Code:	Terminal Length:	Bracket Length:
23	.250" (6.35mm)	.465" (11.8mm)
25	.425" (10.8mm)	.630" (16.0mm)
26	.750" (19.05mm)	.953" (24.2mm)

LEGENDS

NKK Switches can provide custom legends for caps. Contact factory for more information.

Suggested Printable Area for Cap

AT4148

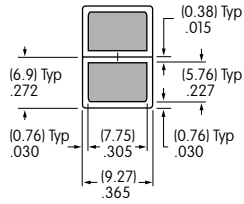

AT4150



AT4156

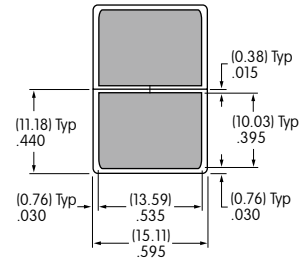

Shaded areas are printable areas.

Recommended Print Method:

Pad Print

Epoxy based ink is recommended.

TYPICAL SWITCH ORDERING EXAMPLE

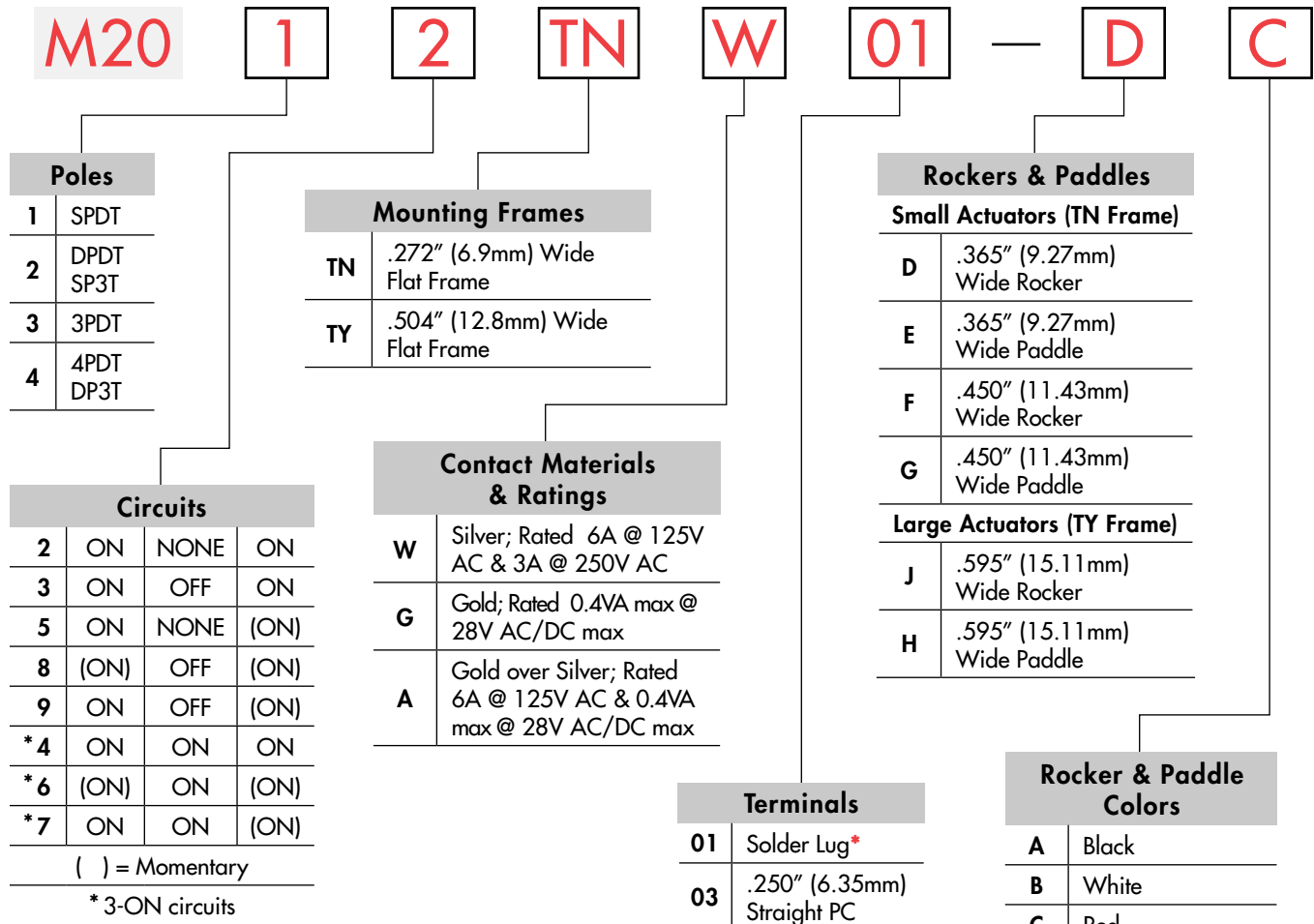

IMPORTANT:



Switches are supplied without UL & CSA marking unless specified.

UL & CSA recognized only when ordered with marking on the switch.

Specific models, ratings, & ordering instructions are noted on General Specifications page.

* Wire harness & cable assemblies offered only in Americas

DESCRIPTION FOR TYPICAL ORDERING EXAMPLE

M2012TNW01-DC

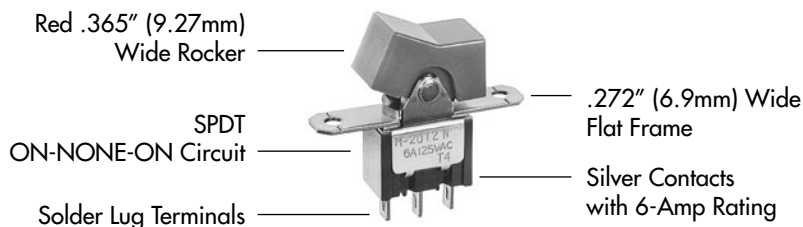

POLES & CIRCUITS

Pole	Model	Rocker Position () = Momentary			Connected Terminals			Throw & Schematics
		Down	Center	Up	Down	Center	Up	
SP	M2012 M2013 M2015 M2018 M2019	ON ON ON (ON) ON	NONE OFF NONE OFF OFF	ON ON (ON) (ON) (ON)	2-3	OPEN	2-1	Note: Terminal numbers are not actually on the switch.
DP	M2022 M2023 M2025 M2028 M2029	ON ON ON (ON) ON	NONE OFF NONE OFF OFF	ON ON (ON) (ON) (ON)	2-3 5-6	OPEN	2-1 5-4	
3P	M2032 M2033 M2035 M2038 M2039	ON ON ON (ON) ON	NONE OFF NONE OFF OFF	ON ON (ON) (ON) (ON)	2-3 5-6 8-9	OPEN	2-1 5-4 8-7	
4P	M2042 M2043 M2045 M2048 M2049	ON ON ON (ON) ON	NONE OFF NONE OFF OFF	ON ON (ON) (ON) (ON)	2-3 5-6 8-9 11-12	OPEN	2-1 5-4 8-7 11-10	

For 3 Throw (3-On)

Connected Terminals & Schematics

Pole	Model	Down	Center	Up	Down	Center	Up
SP	M2024 M2026 M2027	ON (ON) ON	ON ON ON	ON (ON) (ON)			
DP	M2044 M2046 M2047	ON (ON) ON	ON ON ON	ON (ON) (ON)			

The SP3T model utilizes a double pole base.

External connection must be made during field installation.

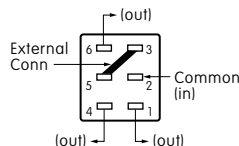

The DP3T model utilizes a four pole base.

External connection must be made during field installation.

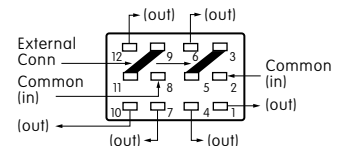

MOUNTING FRAMES

TN .272" (6.9mm)
Wide Flat Frame

Mounting hardware kit HK-1, as shown on the following page, must be ordered separately.

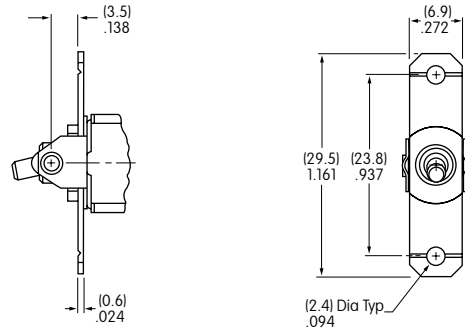

Small Actuators & Panel Cutouts for TN Frame (actuator details on the following pages)

AT4148

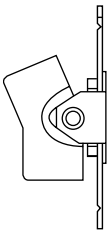

AT4149

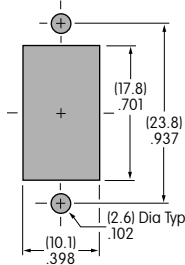
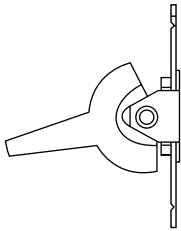

AT4150

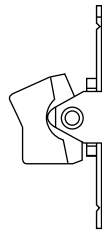

AT4151

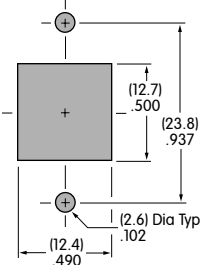
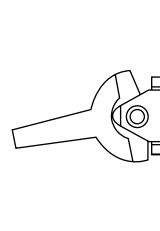

TY .504" (12.8mm)
Wide Flat Frame

Large Actuators & Panel Cutout for TY Frame
(actuator details on the following pages)

Mounting hardware kit HK-2, as shown on the following page, must be ordered separately.

AT4156

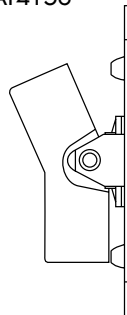

AT4157

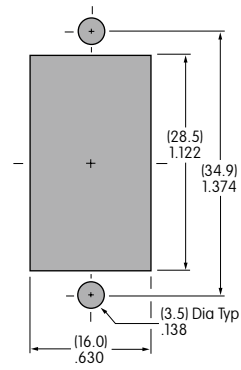
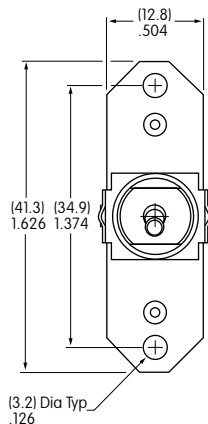
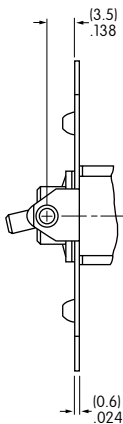
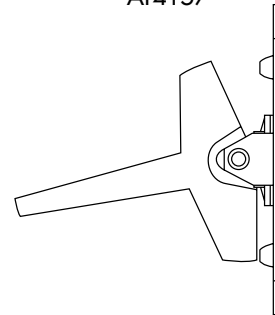

- Toggles
- B** Rockers
- Pushbuttons
- Illuminated PB
- Programmable
- Keylocks
- Rotaries
- Slides
- Tactiles
- Tilt
- Touch
- Indicators
- Accessories
- Supplement

MOUNTING FRAMES (CONTINUED)

Face Panel Mounting

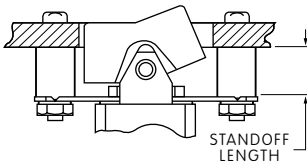

Flat frame devices may also be mounted to the face panel. Standoffs are used to recess the actuator and achieve an attractive front panel appearance.

Subpanel Mounting

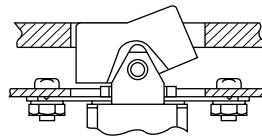

These devices are especially designed for subpanel mounting. When installed on a mounting plate behind the panel, hardware is completely concealed and the front panel retains a clean, attractive appearance.

Optional Hardware Kits for Subpanel or Face Panel Mounting			
Frame	Panel Thickness	Standoff Length	Hardware Kit Number
TN Frame	.125" (3.175mm)	.233" (5.918mm)	ATHK-1
TY Frame	.125" (3.175mm)	.312" (7.925mm)	ATHK-2
Hardware kits include: 2 stainless steel screws, 2 hex nuts, 2 lockwashers, & 2 standoffs			

Optional Snap-in Panel Frames



AT064-1
AT064-2

Further details are shown in the previous bracketed PC mount subsection.



AT065-1
AT065-2

CONTACT MATERIALS & RATINGS

W

Silver over Silver

Power Level

6A @ 125V AC & 3A @ 250V AC

G

Gold over Brass or Copper

Logic Level

0.4VA maximum @ 28V AC/DC maximum

Note: See Supplement section to find complete explanation of operating range.

A

Gold over Silver

**Power Level
or Logic Level**

**6A @ 125V AC
or 0.4VA maximum @ 28V AC/DC maximum**

Note: This dual rated option is suitable when two or more identical switches are used in logic and in power circuits within the same application. See Supplement section to find complete explanation of dual rating and operating range.

TERMINALS

01

Solder Lug

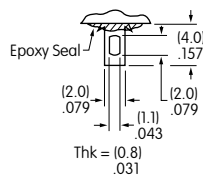

03

**.250" (6.35mm)
Straight PC**

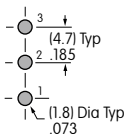
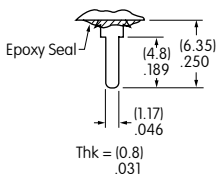

Single Pole

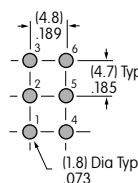

Double Pole

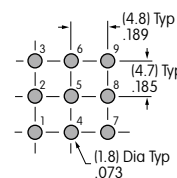

Three Pole

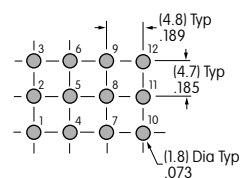

Four Pole

ROCKERS & PADDLES

For TN Frame

D AT4148 .365" (9.27mm)
Wide Rocker

Material: Polyamide
Finish: Matte

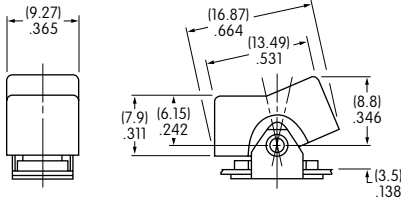

E AT4149 .365" (9.27mm)
Wide Paddle

Material: Polyamide
Finish: Matte

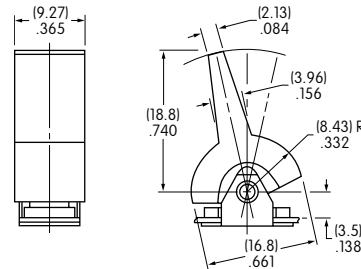

F AT4150 .450" (11.43mm)
Wide Rocker

Material: Polyamide
Finish: Matte

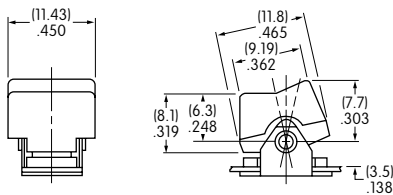

G AT4151 .450" (11.43mm)
Wide Paddle

Material: Polyamide
Finish: Matte

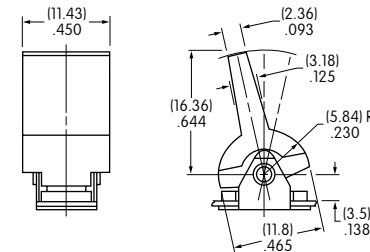

For TY Frame

J AT4156 .595" (15.11mm)
Wide Rocker

Material: Polyamide
Finish: Matte

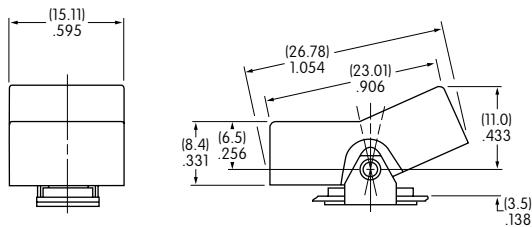
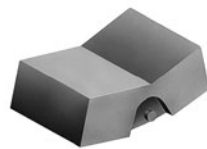

H AT4157 .595" (15.11mm)
Wide Paddle

Material: Polyamide
Finish: Matte

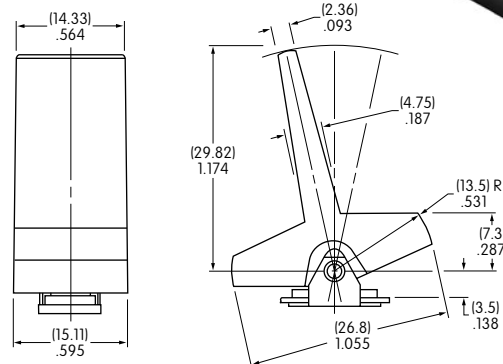

Cap Colors Available:

- A** Black
- B** White
- C** Red
- E** Yellow
- F** Green
- G** Blue
- H** Gray

TYPICAL SWITCH DIMENSIONS

TN Frame • Solder Lug



M2012TNW01-DC

Single Pole

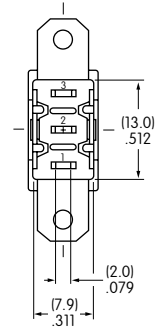
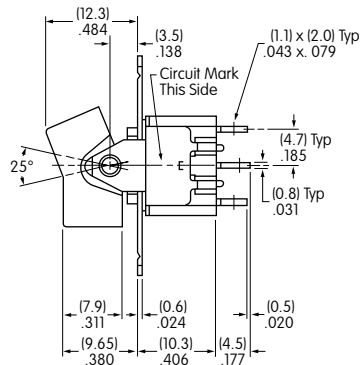
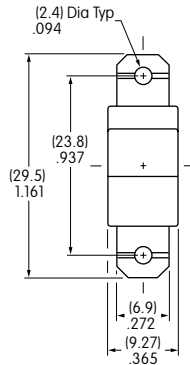

TN Frame • Solder Lug



M2022TNW01-DC

Double Pole

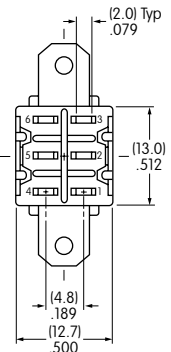
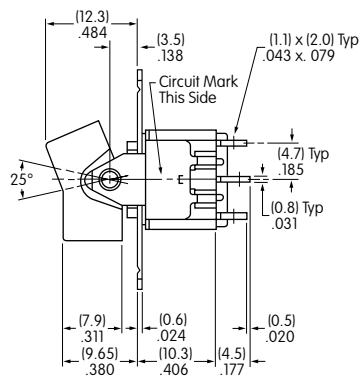
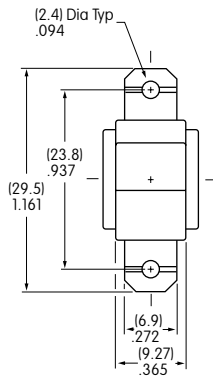

TN Frame • Solder Lug



M2032TNW01-DC

Three Pole

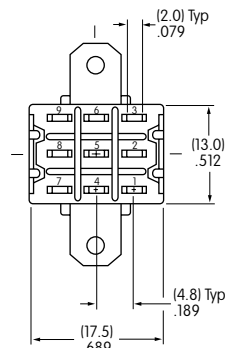
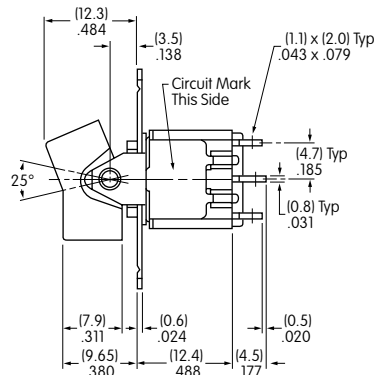
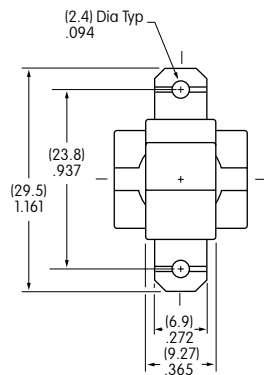

TN Frame • Solder Lug



M2042TNW01-DC

Four Pole

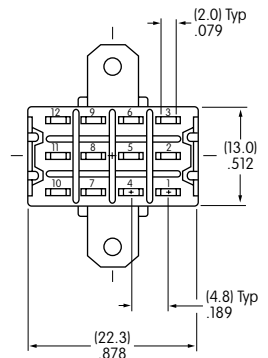
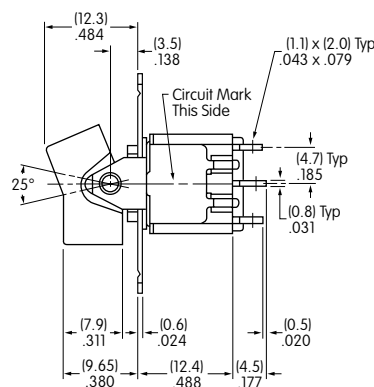
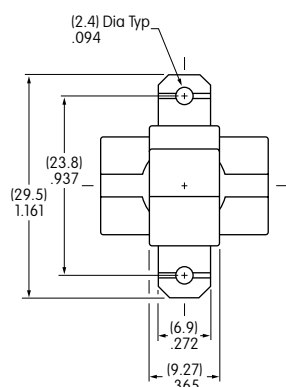

TYPICAL SWITCH DIMENSIONS

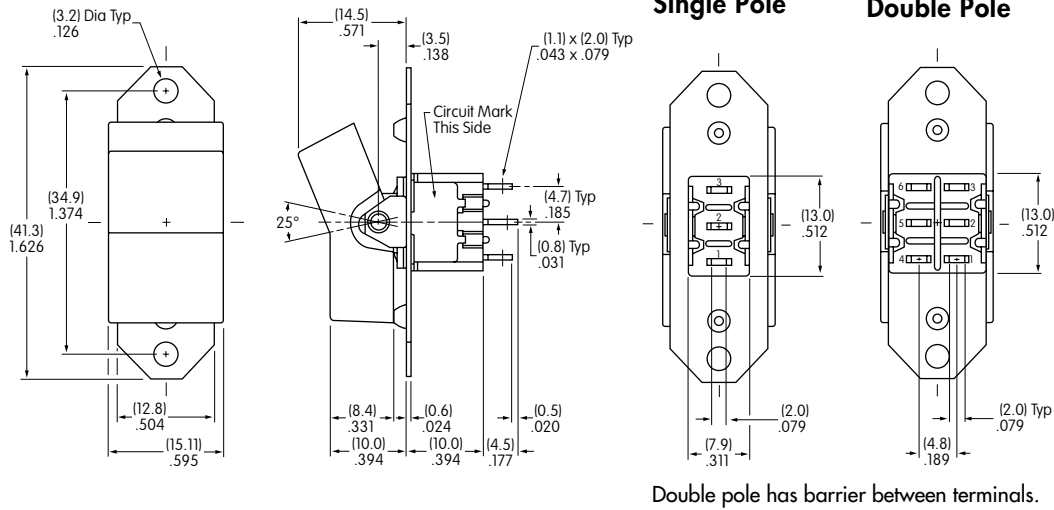

TY Frame • Solder Lug

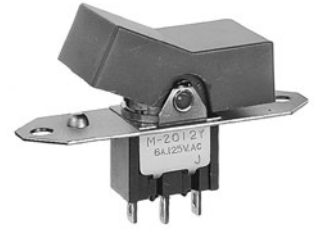

M2012TYW01-JC

Three Pole

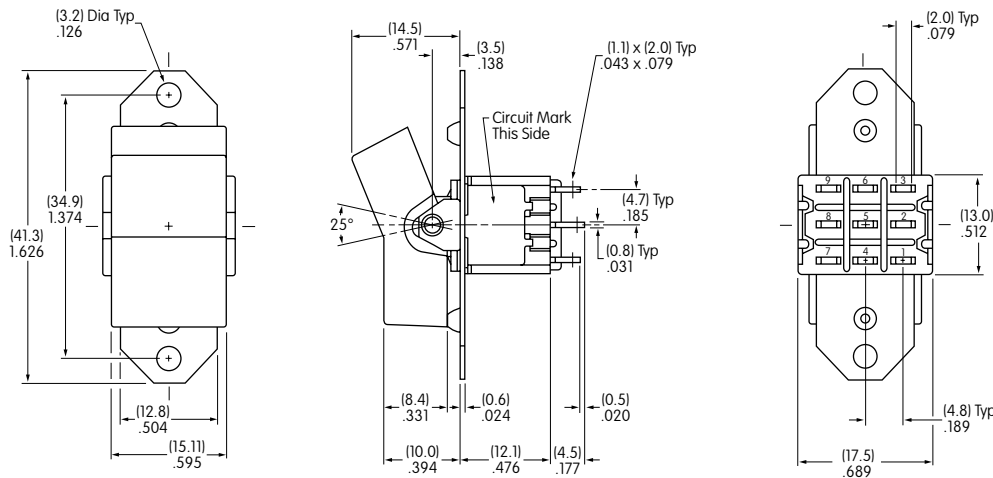

TY Frame • Solder Lug

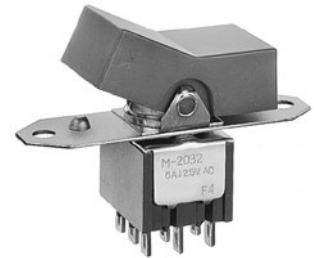

M2032TYW01-JC

Four Pole

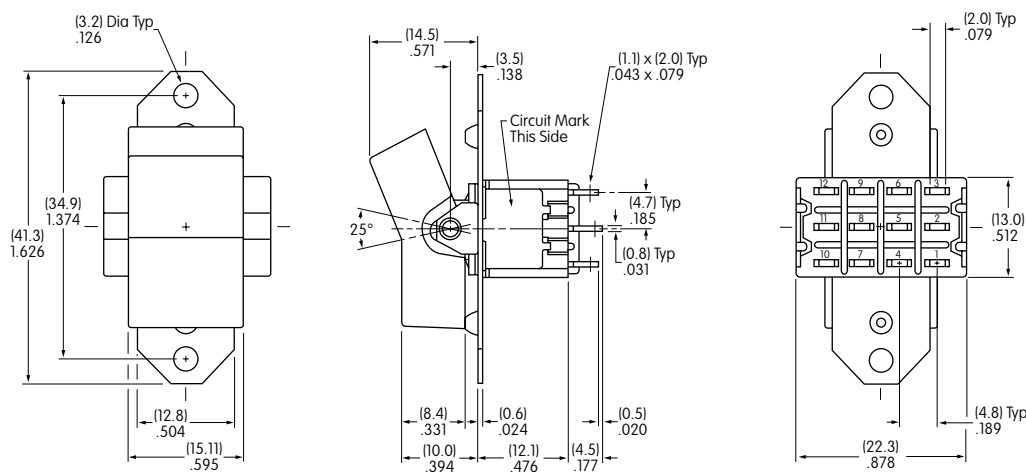

TY Frame • Solder Lug

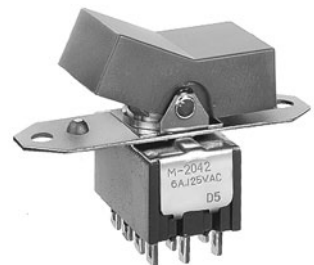

M2042TYW01-JC

LEGENDS

NKK Switches can provide custom legends for caps. Contact factory for more information.

Suggested Printable Area for Caps

AT4148

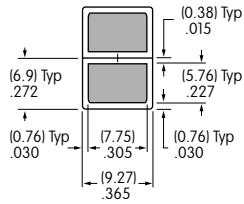

AT4150

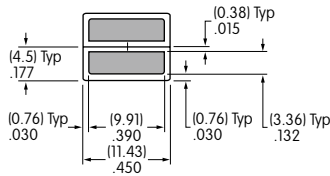

AT4156

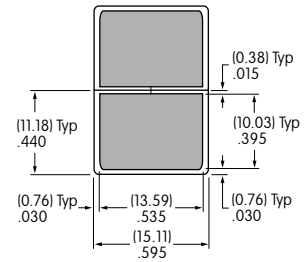
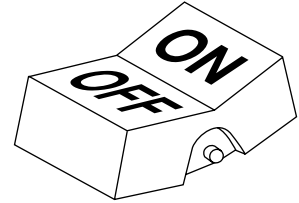

Shaded areas are printable areas.

Recommended Print Method:

Pad Print

Epoxy based ink is recommended.

General Specifications

Toggles

Rockers

Pushbuttons

Illuminated PB

Programmable

Keylocks

Rotaries

Slides

Tactiles

Tilt

Touch

Indicators

Accessories

Supplement

B Electrical Capacity (Resistive Load)

Power Level (silver): 6A @ 125V AC or 3A @ 250V AC or 3A @ 30V DC

Logic Level (gold): 0.4VA maximum @ 28V AC/DC maximum
(Applicable Range 0.1mA ~ 0.1A @ 20mV ~ 28V)

Note: Find additional explanation of operating range in Supplement section.

Other Ratings

Contact Resistance: 10 milliohms maximum for silver; 20 milliohms maximum for gold

Insulation Resistance: 1,000 megohms minimum @ 500V DC

Dielectric Strength: 1,000V AC minimum between contacts for 1 minute minimum;
1,500V AC minimum between contacts & case for 1 minute minimum

Mechanical Life: 50,000 operations minimum

Electrical Life: 25,000 operations minimum

Nominal Operating Force:			On-to-On Position	Off-to-On Position
	Paddles	Single Pole	3.19N	3.92N
		Double Pole	4.41N	7.06N
	Rockers	Single Pole	6.37N	9.80N
		Double Pole	13.73N	17.65N

Angle of Throw: 20°

Materials & Finishes

Housing: Stainless steel

Mounting Bracket: Steel with tin plating

Movable Contacts: Silver alloy or silver alloy with gold plating

Stationary Contacts: Silver with silver plating or copper or brass with gold plating

Lamp Contacts: Phosphor bronze

Base: Diallyl phthalate (UL94V-0)

Switch Terminals: Copper with silver or gold plating

Lamp Terminals: Brass with silver or gold plating

Environmental Data

Operating Temp Range: -10°C through +55°C (+14°F through +131°F) for rockers
-25°C through +70°C (-13°F through +158°F) for paddles

Humidity: 90 ~ 95% humidity for 96 hours @ 40°C (104°F)

Vibration: 10 ~ 55Hz with peak-to-peak amplitude of 1.5mm traversing the frequency range & returning in 1 minute; 3 right angled directions for 2 hours

Shock: 50G (490m/s²) acceleration (tested in 6 right angled directions, with 5 shocks in each direction)

Installation

Soldering Time & Temp: Wave Soldering (PC version): See Profile B in Supplement section.

Manual Soldering: See Profile B in Supplement section.

Note: Lever must be in center position while soldering.

Cleaning: PC mountable device is not process sealed. Hand clean locally using alcohol based solution.

Standards & Certifications

Flammability Standards: UL94V-0 base

UL: **File No. E44145 - Recognized only when ordered with marking on switch.**

Add "/U" before dash in part number to order UL recognized switch.

Single pole rockers with synchronous circuits & single color LEDs & solder lug or PC recognized at 6A @ 125V AC.

CSA: **File No. 023535_0_000 - Certified only when ordered with marking on switch.**

Add "/C" before dash in part number to order CSA certified switch.

All single pole rockers with synchronous circuits & single color LEDs certified at 6A @ 125V AC.

TYPICAL SWITCH ORDERING EXAMPLE

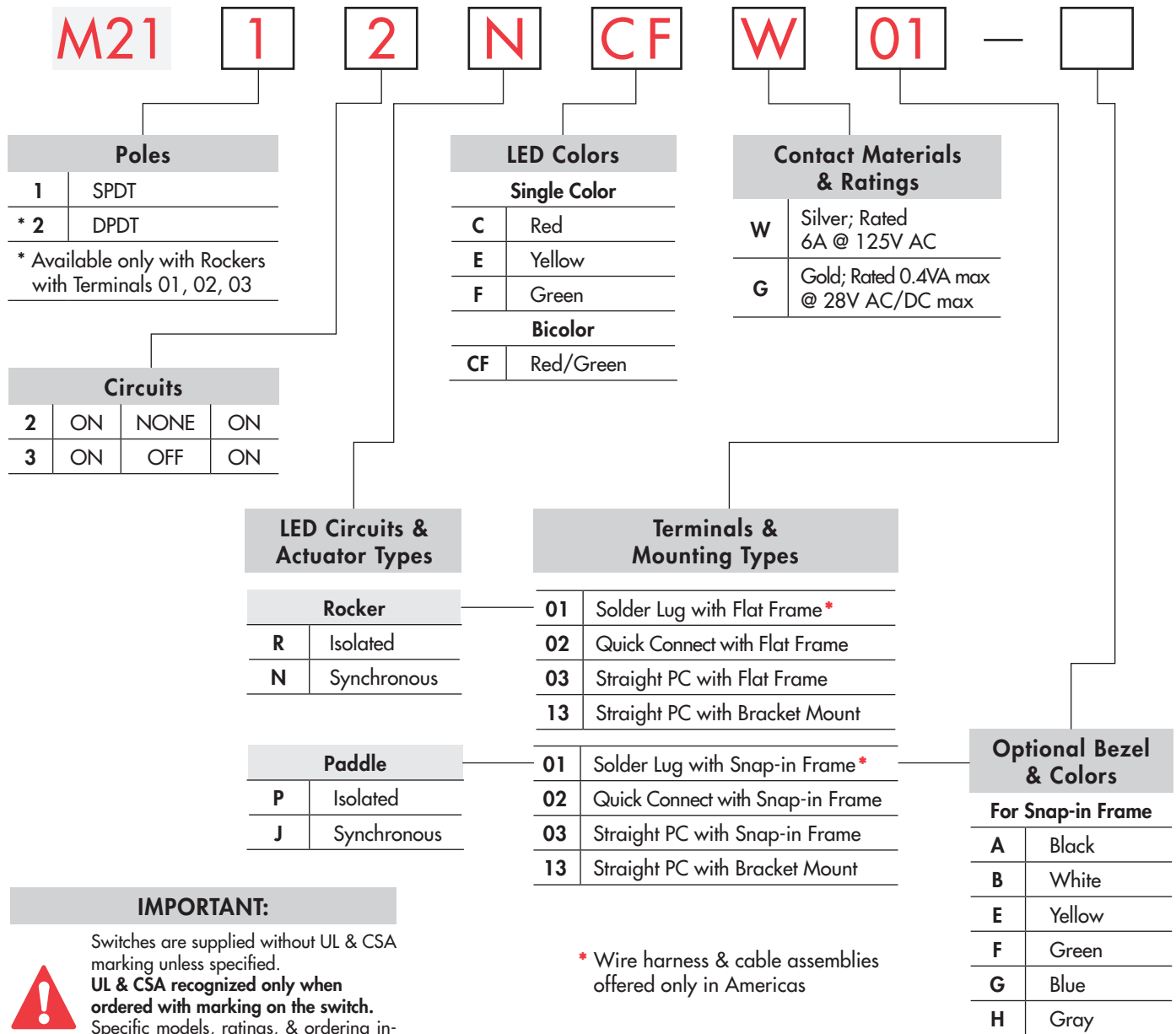

IMPORTANT:

Switches are supplied without UL & CSA marking unless specified. **UL & CSA recognized only when ordered with marking on the switch.** Specific models, ratings, & ordering instructions are noted on General Specifications page.

* Wire harness & cable assemblies offered only in Americas

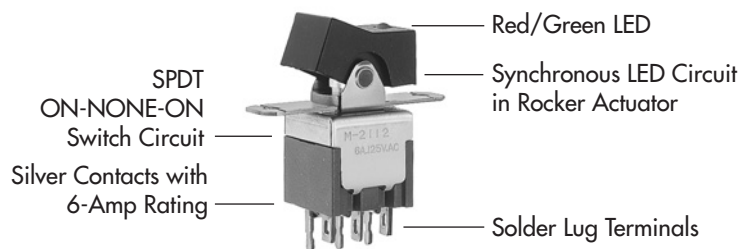

DESCRIPTION FOR TYPICAL ORDERING EXAMPLE

M2112NCFW01



Toggles
Rockers
Pushbuttons
Illuminated PB
Programmable
Keylocks
Rotaries
Slides
Tactiles
Tilt
Touch
Indicators
Accessories
Supplement

POLES & CIRCUITS & LED ILLUMINATION

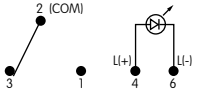
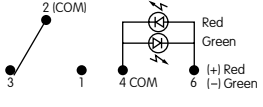
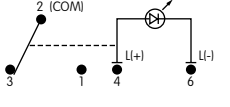
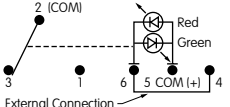
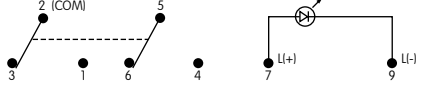
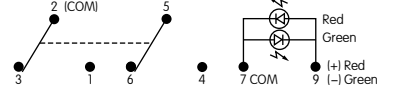
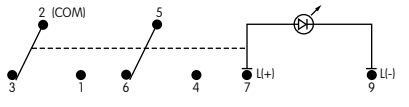
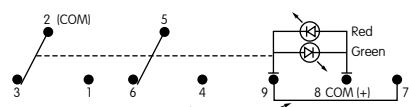
Model	Pole & Throw	Toggle Position & Terminal Numbers			Schematics
		Down 	Center 	Up 	
M2112 Connected Power Terminals	SPDT	ON 2-3	NONE NONE	ON 2-1	Notes: Terminal numbers are not actually on the switch. LEDs require an external power source.  
LED Circuit	Isolated LEDs (see schematics) Connected LED Terminals	ON 4-6	NONE NONE	ON 4-6	
	Synchronous Single Color LED Connected LED Terminals	ON 4-6	NONE NONE	OFF OPEN	
	Synchronous Bicolor LED Connected LED Terminals	Red 5-6	NONE NONE	Green 5-4	
M2113 Connected Power Terminals	SPDT	ON 2-3	OFF OPEN	ON 2-1	 
LED Circuit	Isolated LEDs (see schematics) Connected LED Terminals	ON 4-6	ON 4-6	ON 4-6	
	Synchronous Single Color LED Connected LED Terminals	ON 4-6	OFF OPEN	ON 4-6	
	Synchronous Bicolor LED Connected LED Terminals	Red 5-6	OFF OPEN	Green 5-4	
M2122 Connected Power Terminals	DPDT	ON 2-3 5-6	NONE NONE	ON 2-1 5-4	 
LED Circuit	Isolated LEDs (see schematics) Connected LED Terminals	ON 7-9	NONE NONE	ON 7-9	
	Synchronous Single Color LED Connected LED Terminals	ON 7-9	NONE NONE	OFF OPEN	
	Synchronous Bicolor LED Connected LED Terminals	Red 8-9	NONE NONE	Green 8-7	
M2123 Connected Power Terminals	DPDT	ON 2-3 5-6	OFF OPEN	ON 2-1 5-4	 
LED Circuit	Isolated LEDs (see schematics) Connected LED Terminals	ON 7-9	ON 7-9	ON 7-9	
	Synchronous Single Color LED Connected LED Terminals	ON 7-9	OFF OPEN	ON 7-9	
	Synchronous Bicolor LED Connected LED Terminals	Red 8-9	OFF OPEN	Green 8-7	

LED COLORS & SPECIFICATIONS

The electrical specifications shown are determined at a basic temperature of 25°C. LED circuit is isolated and requires an external power source. If the source voltage exceeds the rated voltage, a ballast resistor is required. The resistor value can be calculated by using the formula in Supplement Section. The LED is an integral part of the switch and not available separately. Bicolor LED is translucent white when unlit.

		Rockers				Paddles				Units
		Single Color		Bicolor	Single Color		Bicolor			
		C	E	F	CF	C	E	F	CF	
Forward Peak Current	I_{FM}	25	30	30	25	10	30	30	30/25	mA
Typical Forward Current	I_F	20	20	20	20	8	24	24	20/20	mA
Forward Voltage	V_F	2.1	2.1	2.1	1.7/2.0	1.9	2.0	2.1	2.0/2.2	V
Reverse Peak Voltage	V_{RM}	4	4	4	—	5	5	5	—	V
Current Reduction Rate Above 25°C	ΔI_F	0.33	0.40	0.40	0.33/0.33	0.13	0.40	0.40	0.43/0.38	mA/°C
Ambient Temperature Range		-10° ~ +55°C				-25° ~ +70°C				

LED CIRCUIT, ROCKER, & MOUNTING TYPE COMBINATIONS

- R** Rocker with Isolated LED Circuit
- N** Rocker with Synchronous LED Circuit

Material: Polyamide
 Finish: Matte
 Color: Black

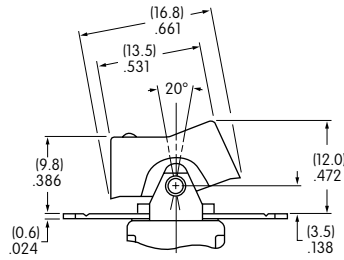

Flat Frame combines with Terminal codes 01, 02, & 03.

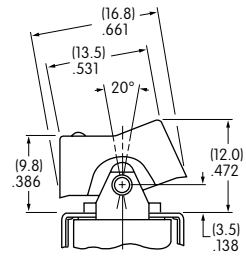

Bracket combines with Terminal code 13.

Maximum Panel Thickness .126" (3.2mm)

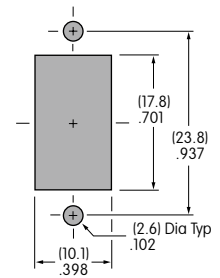

TYPICAL ROCKER SWITCH DIMENSIONS

Single Pole

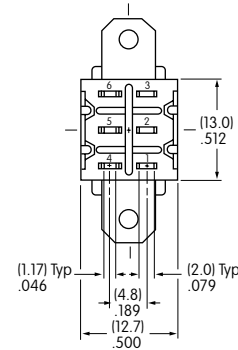
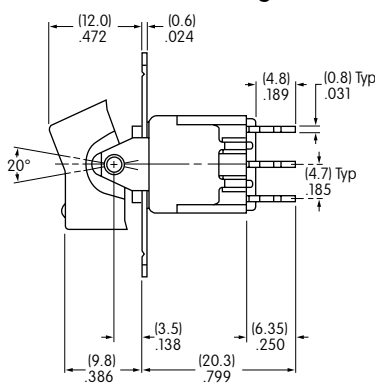
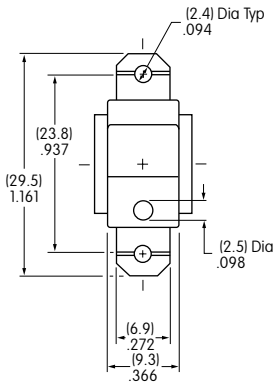

Single color LED switch does not have terminal 5.

Solder Lug



M2112NCFW01

Double Pole

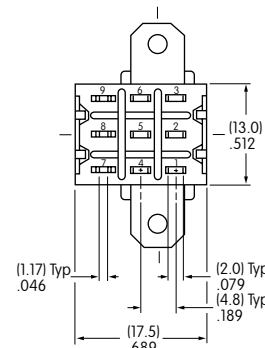
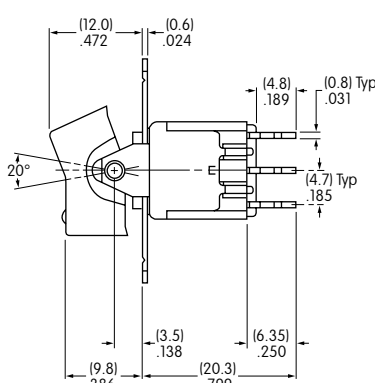
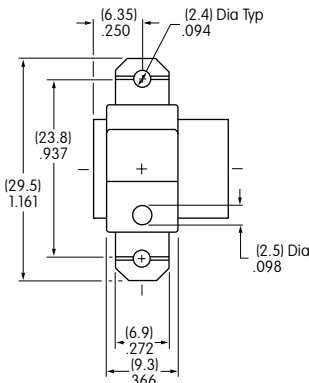

Single color LED switch does not have terminal 8.

Solder Lug



M2122NCFW01

Single Pole Only

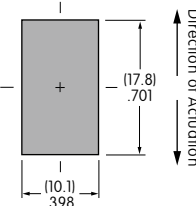
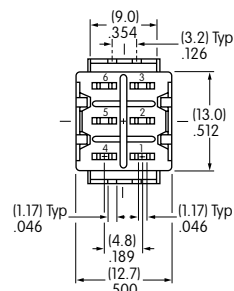
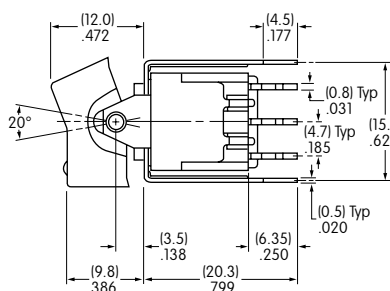
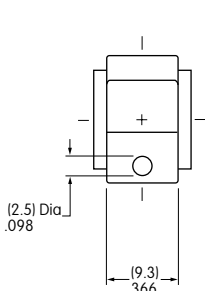

Straight PC • Bracket



M2112NCFW13

Single color LED switch does not have terminal 5. Silver contact material is standard.

LED CIRCUIT, PADDLE, & MOUNTING TYPE COMBINATIONS

P Paddle with Isolated LED Circuit

J Paddle with Synchronous LED Circuit

Maximum Panel Thickness
 .039" ~ .126" (1.0 ~ 3.2mm)
 without Bezel
 .039" ~ .098" (1.0 ~ 2.5mm)
 with Bezel

Maximum Panel Thickness
 .126" (3.2mm)

Material: Polyamide
 Finish: Matte
 Color: Black

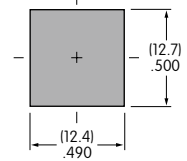
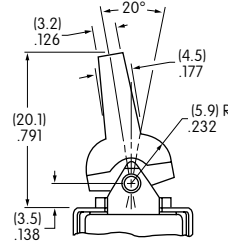
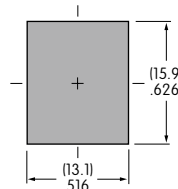
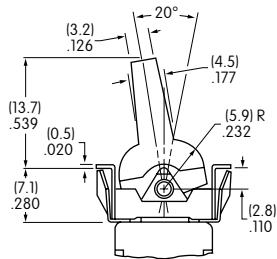

Snap-in combines with Terminal codes 01, 02, & 03

Bracket combines with Terminal code 13

TYPICAL PADDLE SWITCH DIMENSIONS

Solder Lug • Snap-in

Single Pole Only

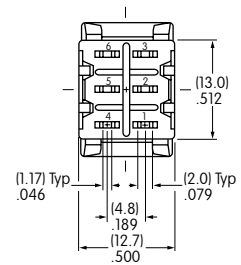
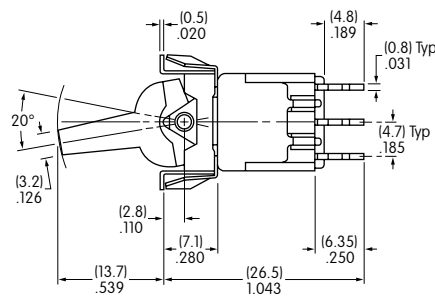
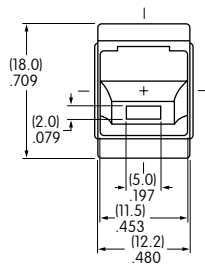

M2112JCFW01

Single color LED switch does not have terminal 5.

Straight PC • Bracket

Single Pole Only

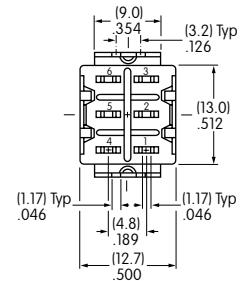
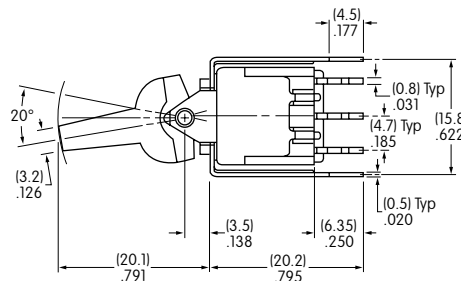
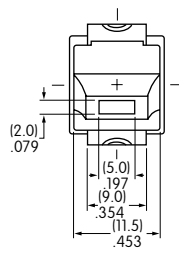

M2112JCFW13

Silver contact material is standard. Single color LED switch does not have terminal 5.

CONTACT MATERIALS & RATINGS

W Silver over Silver Power Level 6A @ 125V AC & 3A @ 250V AC

G Gold over Brass or Copper Logic Level 0.4VA maximum @ 28V AC/DC maximum

Complete explanation of operating range in Supplement section.

TERMINALS

01 Solder Lug with Turret LED Terminal

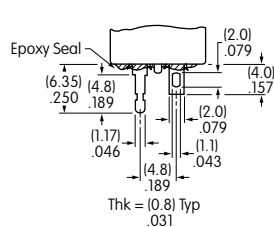

02 Quick Connect

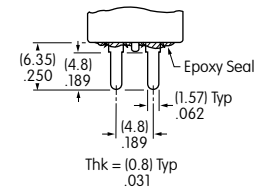

03 Straight PC with Turret LED Terminal

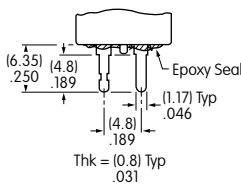

Single Pole

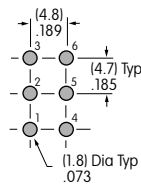

Single color LED & isolated bicolor LED switches do not have terminal 5.

Double Pole

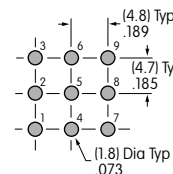

Single color LED & isolated bicolor LED switches do not have terminal 8.

13 Straight PC with Bracket & Turret LED Terminal

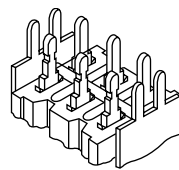

Single Pole

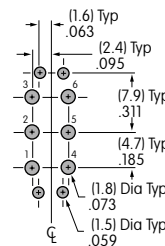

Single color LED & isolated bicolor LED switches do not have terminal 5.

OPTIONAL BEZEL & COLORS

AT2107 Bezel for Snap-in Panel Frame

Material: Polyamide

Finish: Matte

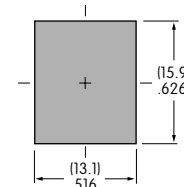
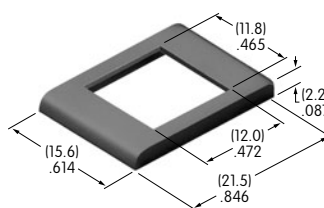

Colors Available: **A** Black **B** White **E** Yellow **F** Green **G** Blue **H** Gray

General Specifications

Toggles

Rockers
B

Pushbuttons

Illuminated PB

Programmable

Keylocks

Rotaries

Slides

Tactiles

Tilt

Touch

Indicators

Accessories

Supplement

Electrical Capacity (Resistive Load)

Power Level (silver): 6A @ 125V AC or 3A @ 250V AC;
4A @ 30V DC (On-On circuit) & 3A @ 30V DC (all other circuits)

Logic Level (gold): 0.4VA maximum @ 28V AC/DC maximum
(Applicable Range 0.1mA ~ 0.1A @ 20mV ~ 28V)

Logic/Power Level (gold over silver): Combines silver & gold ratings
Note: Find additional explanation of dual rating & operating range in Supplement section.

Other Ratings

Contact Resistance: 10 milliohms maximum for silver; 20 milliohms maximum for gold

Insulation Resistance: 1,000 megohms minimum @ 500V DC

Dielectric Strength: 1,000V AC minimum between contacts for 1 minute minimum;
1,500V AC minimum between contacts & case for 1 minute minimum

Mechanical Life: 50,000 operations minimum

Electrical Life: 25,000 operations minimum for silver; 50,000 operations minimum for gold

Contact Timing: Nonshorting (break-before-make)

Angle of Throw: 26°

Materials & Finishes

Lever: Brass with nickel plating

Actuator Clip: Polyacetal

Support Bracket: Brass with tin plating

Bushing/Housing: Glass fiber reinforced polyamide (UL94V-0)

Sealing Ring: Nitrile butadiene rubber

Base: Glass fiber reinforced polyamide (UL94V-0)

Movable Contacts: Silver alloy with silver plating (code W); copper or phosphor bronze with gold plating (code G);
or silver alloy with gold plating (code A)

Stationary Contacts: Silver alloy with silver plating (code W); copper or brass with gold plating (code G);
or silver alloy with gold plating (code A)

Terminals: Copper or brass with silver or gold plating

Environmental Data

Operating Temp Range: -30°C through +85°C (-22°F through +185°F)

Humidity: 90 ~ 95% humidity for 96 hours @ 40°C (104°F)

Vibration: 10 ~ 55Hz with peak-to-peak amplitude of 1.5mm traversing the frequency range & returning
in 1 minute; 3 right angled directions for 2 hours

Shock: 50G (490m/s²) acceleration (tested in 6 right angled directions, with 5 shocks in each direction)

PCB Processing

Soldering: Wave Soldering Recommended: See Profile B in Supplement section.

Manual Soldering: See Profile B in Supplement section.

Cleaning: Automated cleaning. See Cleaning specifications in Supplement section.

Standards & Certifications

Flammability Standards: UL94V-0 rated bushing/housing & base

UL: **File No. E44145 - Recognized only when ordered with marking on switch.**

Add "/U" or "/CUL" before dash in part number to order UL recognized switch.

All models recognized at 6A @ 125V AC, 3A @ 250V AC, & 4A @ 30V DC or 0.4A @ 28V DC.

CSA: **File No. 023535_0_000 - Certified only when ordered with marking on switch.**

Add "/C" before dash in part number to order CSA certified switch.

All models certified at 6A @ 125V AC, 3A @ 250V AC, & 4A @ 30V DC.

Distinctive Characteristics

Antijamming design protects against mechanism damage from downward force on the actuator.

O-ring surrounding top of lever prevents liquids from reaching switch mechanism.

Ultrasonic welding of upper and lower housing seals out contaminants and allows automated soldering and cleaning.

Terminals are epoxy sealed to prevent entry of flux, solvents, and other contaminants.

Bracketed models have crimped bracket legs to ensure secure PC mounting and prevent dislodging during automated soldering.

Logic level and power capabilities are available to suit varying applications.

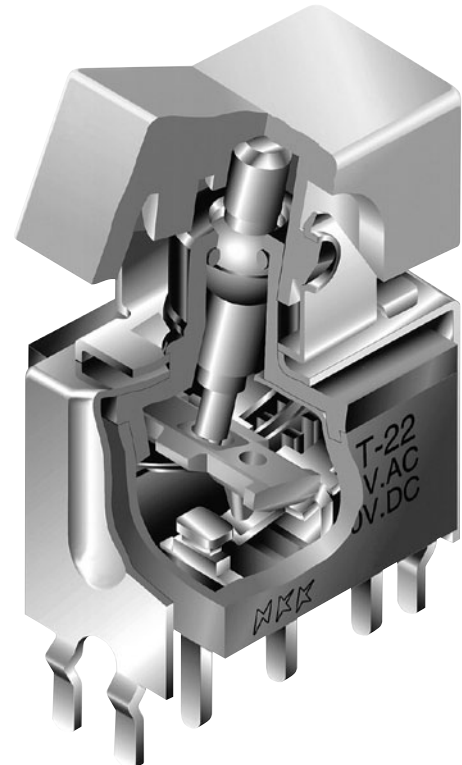

Actual Size

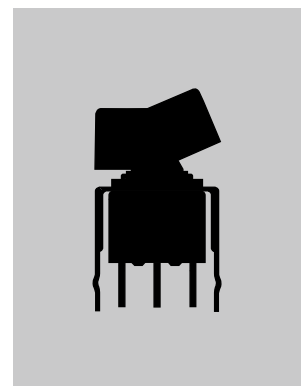

Supplement	Accessories	Indicators	Touch	Tilt	Tactiles	Slides	Rotaries	Keylocks	Programmable	Illuminated PB	Pushbuttons	Rockers	Toggle
------------	-------------	------------	-------	------	----------	--------	----------	----------	--------------	----------------	-------------	---------	--------

TYPICAL SWITCH ORDERING EXAMPLE

M2T

2

2

TX

G

41

D

C

Poles

1	SPDT
2	DPDT

Circuits

2	ON	NONE	ON
3	ON	OFF	ON
5	ON	NONE	(ON)
8	(ON)	OFF	(ON)
9	ON	OFF	(ON)

() = Momentary

Mounting Frame

TX	For Actuators with Straight or Angle PC Mount
----	---

Contact Materials & Ratings

W	Silver; Rated 6A @ 125V AC & 3A @ 250V AC
G	Gold; Rated 0.4VA max @ 28V AC/DC max
A	Gold over Silver; Rated 6A @ 125V AC & 0.4VA max @ 28V AC/DC max

PC Terminals

13	Straight with .460" (11.7mm) Bracket
30	.150" (3.81mm) Right Angle
41	.150" (3.81mm) Vertical

Rockers/Paddles

D	.365" (9.27mm) Wide Rocker
E	.365" (9.27mm) Wide Paddle
F	.450" (11.43mm) Wide Rocker
G	.450" (11.43mm) Wide Paddle

Rocker/Paddle Colors

A	Black
B	White
C	Red
E	Yellow
F	Green
G	Blue
H	Gray

IMPORTANT:



Switches are supplied without UL, cULus & CSA marking unless specified. **UL, cULus & CSA recognized only when ordered with marking on the switch.** Specific models, ratings, & ordering instructions are noted on General Specifications page.

DESCRIPTION FOR TYPICAL ORDERING EXAMPLE

M2T22TXG41-DC

Mounting Frame for Actuators with Straight or Angle PC Mount

.365" (9.27mm) Wide Red Rocker

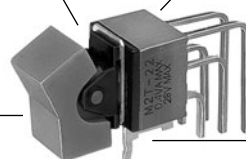

DPDT ON-NONE-ON Circuit

.150" (3.81mm) Vertical Terminals

Gold Contacts with 0.4VA Rating

POLES & CIRCUITS

Pole	Model	Rocker Position () = Momentary			Connected Terminals			Throw & Schematics
		Down	Center	Up	Down	Center	Up	
SP	M2T12 M2T13 M2T15 M2T18 M2T19	ON ON ON (ON) ON	NONE OFF NONE OFF OFF	ON ON (ON) (ON) (ON)	2-3	OPEN	2-1	Note: Terminal numbers are not actually on the switch. SPDT
DP	M2T22 M2T23 M2T25 M2T28 M2T29	ON ON ON (ON) ON	NONE OFF NONE OFF OFF	ON ON (ON) (ON) (ON)	2-3 5-6	OPEN	2-1 5-4	DPDT

MOUNTING FRAME

TX

Mounting Frame for Rockers or Paddles with Straight or Angle PC Terminals

Straight PC Mounting

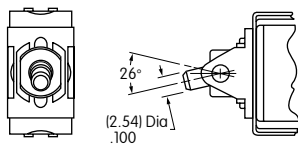

Right Angle PC Mounting

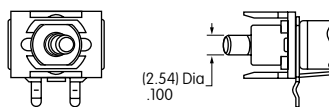

Vertical PC Mounting

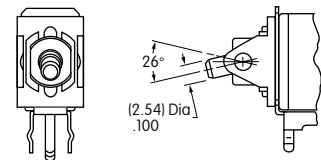

Actuators & Panel Cutouts

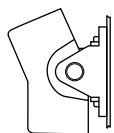

AT4148

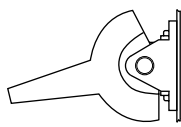

AT4149

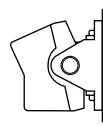
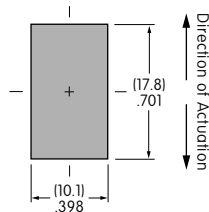

AT4150

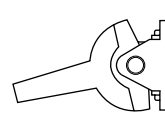

AT4151

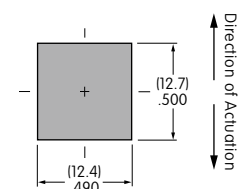

CONTACT MATERIALS & RATINGS

W

Silver over Silver

Power Level

6A @ 125V AC & 3A @ 250V AC

G

Gold over Brass or Copper

Logic Level

0.4VA maximum @ 28V AC/DC maximum

Complete explanation of operating range in Supplement section.

A

Gold over Silver

Power Level
or Logic Level

6A @ 125V AC
or 0.4VA maximum @ 28V AC/DC maximum

Note: This dual rated option is suitable when two or more identical switches are used in logic and in power circuits within the same application. See Supplement section for complete explanation of dual rating and operating range.

Toggle

Rockers **B**

Pushbuttons

Illuminated PB

Programmable

Keylocks

Rotaries

Slides

Tactiles

Tilt

Touch

Indicators

Accessories

Supplement

PC TERMINALS

13 Straight with
.460" (11.7mm)
Bracket

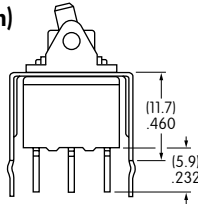

30 .150" (3.81mm)
Right Angle

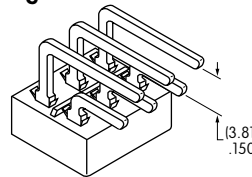

41 .150" (3.81mm)
Vertical

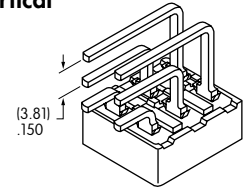

ROCKERS & PADDLES

D AT4148
.365" (9.27mm) Wide Rocker

Material: Polyamide
Finish: Matte

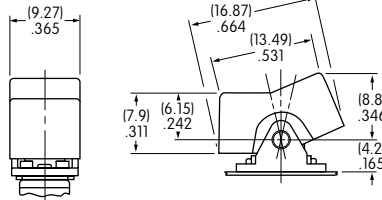

E AT4149
.365" (9.27mm) Wide Paddle

Material: Polyamide
Finish: Matte

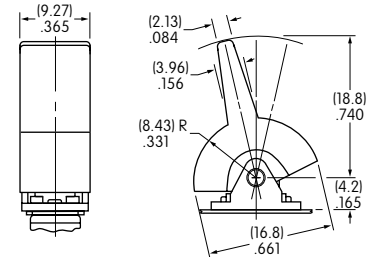

F AT4150
.450" (11.43mm) Wide Rocker

Material: Polyamide
Finish: Matte

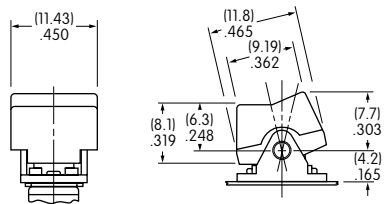

G AT4151
.450" (11.43mm) Wide Paddle

Material: Polyamide
Finish: Matte

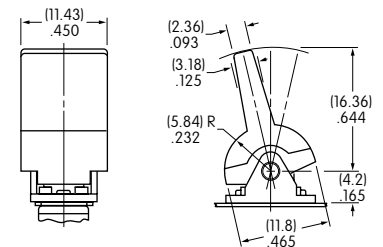

Cap Colors Available:

- A** Black
- B** White
- C** Red
- E** Yellow
- F** Green
- G** Blue
- H** Gray

TYPICAL SWITCH DIMENSIONS

Straight PC • Bracket

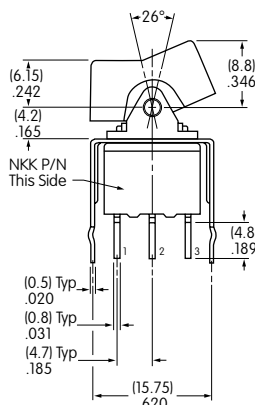

Single Pole

Double Pole

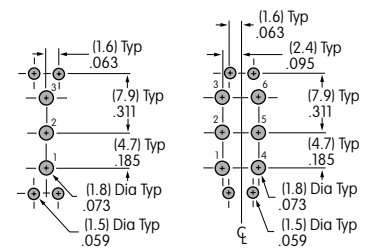
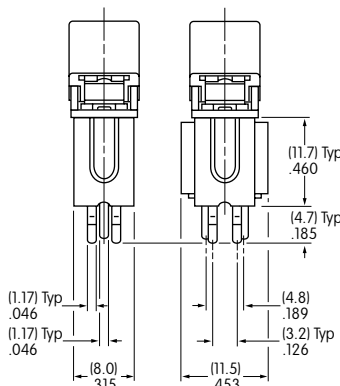

M212TXG13-DC

TYPICAL SWITCH DIMENSIONS

Single Pole

Right Angle PC

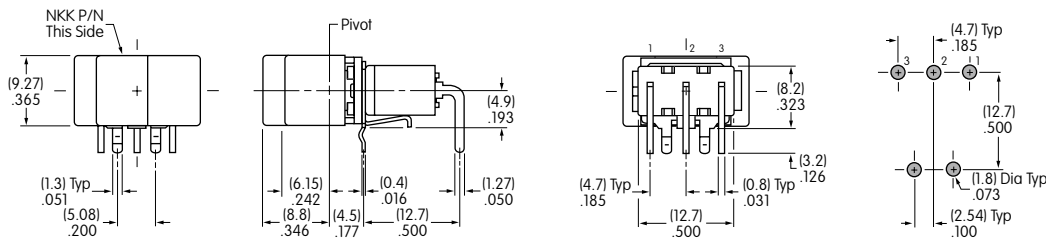

M2T12TXG30-DC

Double Pole

Right Angle PC

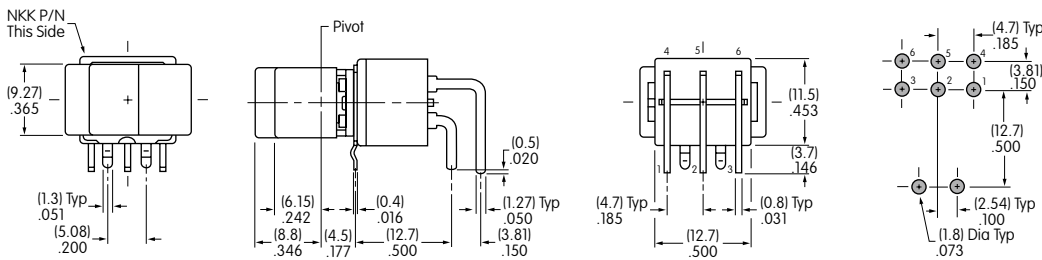

M2T22TXG30-DC

Single Pole

Vertical PC

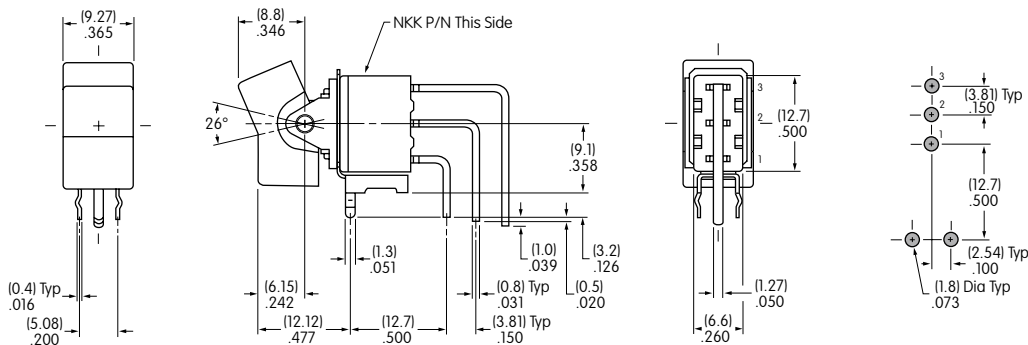

M2T12TXG41-DC

Double Pole

Vertical PC

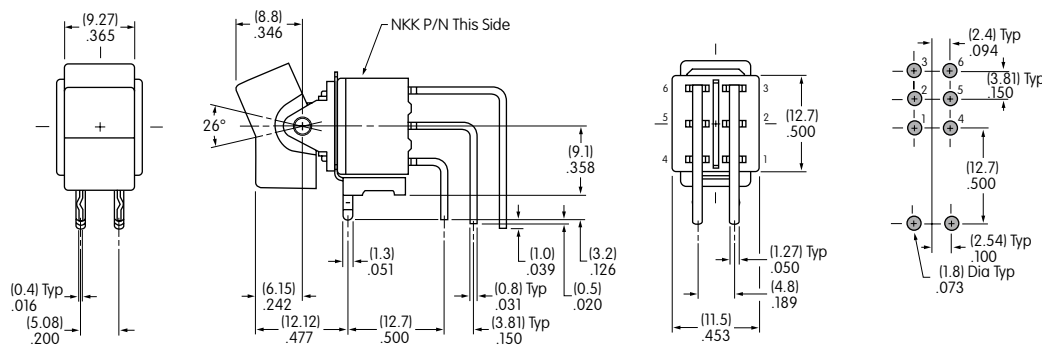

M2T22TXG41-DC

LEGENDS

NKK Switches can provide custom legends for caps. Contact factory for more information.

Suggested Printable Area for Cap



AT4148



AT4150

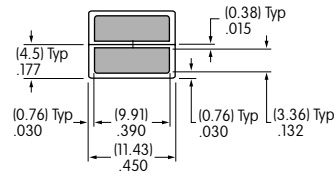
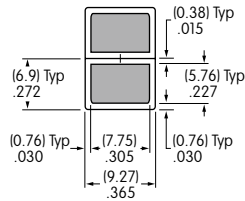

Shaded areas are printable areas.

Recommended Print Method:

Pad Print

Epoxy based ink is recommended.

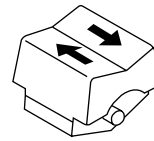

General Specifications

Electrical Capacity

Power Level: 5A @ 125V AC, 3A @ 250V AC, & 3A @ 30V DC

Other Ratings

Contact Resistance: 10 milliohms maximum

Insulation Resistance: 200 megohms minimum @ 500V DC

Dielectric Strength: 1,000V AC minimum between contacts for 1 minute minimum;
1,500V AC minimum between contacts & case for 1 minute minimum

Mechanical Life: 30,000 operations minimum

Electrical Life: 10,000 operations minimum

Nominal Operating Force: 9.94N for rockers & 4.41N for paddles

Angle of Throw: 24° for On-None-(On); 28° for all other circuits

Materials & Finishes

Housing: Stainless steel

Movable Contacts: Silver alloy

Stationary Contacts: Silver

Base: Phenolic resin

Common Terminal: Copper with silver plating

End Terminals: Copper with silver plating

Lamp Terminals: Phosphor bronze with nickel plating

Environmental Data

Operating Temperature Range: -10°C through +50°C (+14°F through +122°F)

Humidity: 90 ~ 95% humidity for 96 hours @ 40°C (104°F)

Vibration: 10 ~ 55Hz with peak-to-peak amplitude of 1.5mm traversing the frequency range & returning in 1 minute; 3 right angled directions for 2 hours

Shock: 50G (490m/s²) acceleration (tested in 3 right angled directions, with 3 shocks in each direction)

Installation

Cap Installation Force: 9.80N (2.2 lbf) for rockers;

19.61N (4.4 lbf) for paddle

Soldering Time & Temperature: Manual Soldering: See Profile A in Supplement section.

Standards & Certifications

UL: File No. E44145 - Recognized only when ordered with marking on switch.

Add "/U" or "/CUL" before first dash in part number to order UL recognized switch.

All models recognized at 5A @ 125V AC & 3A @ 250V AC.

Distinctive Characteristics

Industry's first miniature snap-in, lighted rocker switch.

Actuators in various styles operate with firm, well-defined movements.

Interlocking actuator prevents switch failure due to jamming or window locking.

Two bezel sizes adapt to varied panel cutouts.

Unique stainless steel retaining clips securely hold switches over a range of panel thicknesses, even when exposed to vibration.

Space conserving front panel mounting with minimum behind panel dimension of .902" (22.9mm).

Durable stainless steel housing prevents corrosion.

Isolated lamp circuit for incandescent, LED, and neon lamps. Front panel relamping.

Built-in protective cover shields contacts from dust.

Epoxy sealed solder lug terminals lock out flux, dust, and other contaminants.

Extended lamp terminal for ease of wiring.

Matching indicators available.

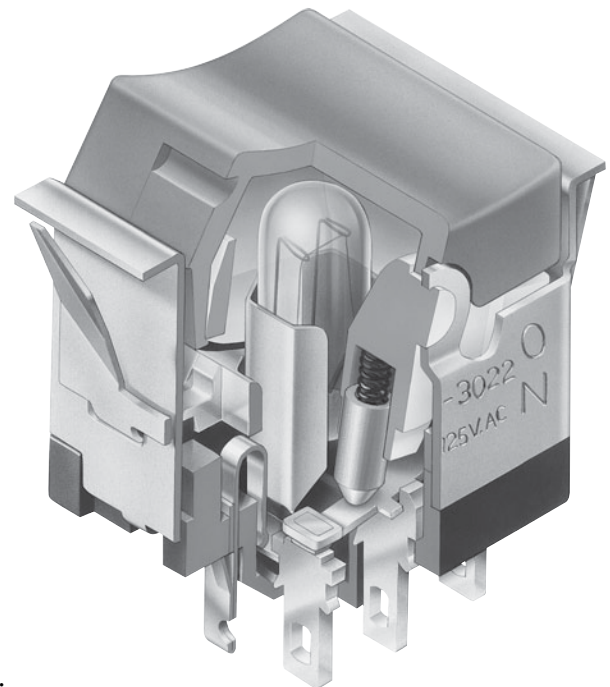

Actual Size

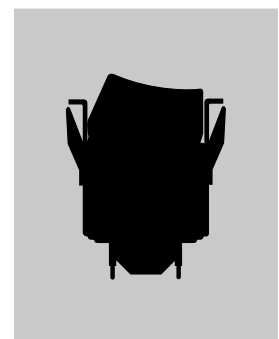

- Supplement
- Accessories
- Indicators
- Touch
- Tilt
- Tactiles
- Slides
- Rotaries
- Keylocks
- Programmable
- Illuminated PB
- Pushbuttons
- B** Rockers
- Toggle

TYPICAL SWITCH ORDERING EXAMPLE

MLW30

2

5

12

DC

1A

Poles

1	SPDT
2	SP3T DPDT

Circuits

2	ON	NONE	ON
3	ON	OFF	ON
5	ON	NONE	(ON)
8	(ON)	OFF	(ON)
9	ON	OFF	(ON)
0	ON	ON	ON

() = Momentary

Lamps

Incandescent & Neon Lamps

00	No Lamp
06	6-volt
12	12-volt
18	18-volt
24	24-volt
28	28-volt
N	110-volt (not suitable with green & blue)

Single Element LED Colors

C	Red
E	Yellow
F	Green

Cap Types & Colors

Rocker

RA	Black
RB	White
RC	Red
RD	Orange
RE	Yellow
RF	Green
RG	Blue

Paddle

PA	Black
PB	White
PC	Red
PD	Orange
PE	Yellow
PF	Green
PG	Blue

Design Rocker

DB	White
DC	Red
DD	Orange
DF	Green
DG	Blue

LED Rocker

LB	White
LC	Red
LE	Yellow
LF	Green

Sculptured Rocker

SB	White
SC	Red
SE	Yellow
SF	Green

Bezels/Colors

Standard

1A	Black
1B	White
1C	Red
1D	Orange
1E	Yellow
1F	Green
1G	Blue
1H	Gray

Large

2A	Black
2B	White
2C	Red
2D	Orange
2E	Yellow
2F	Green
2G	Blue
2H	Gray

DESCRIPTION FOR TYPICAL ORDERING EXAMPLE

MLW3025-12-DC-1A

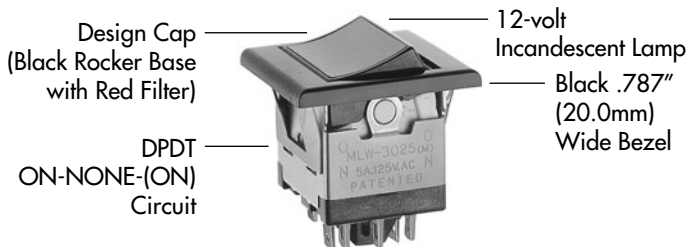

Note: Wire harness & cable assemblies offered only in Americas

IMPORTANT:

Switches are supplied without UL & cULus markings unless specified. **UL & cULus recognized only when ordered with marking on the switch.** Specific models & ratings noted on General Specifications page.



POLES & CIRCUITS

Pole	Model	Rocker Position () = Momentary			Connected Terminals			Throw & Power/Lamp Schematics
		Up	Center	Down	Up	Center	Down	
SP	MLW3012 MLW3013 MLW3015 MLW3018 MLW3019	ON ON ON (ON) ON	NONE OFF NONE OFF OFF	ON ON (ON) (ON) (ON)	2-1	OPEN	2-3	Notes: Terminal numbers are not actually on switch. Lamp circuit is isolated and requires an external power source. SPDT
DP	MLW3022 MLW3023 MLW3025 MLW3028 MLW3029	ON ON ON (ON) ON	NONE OFF NONE OFF OFF	ON ON (ON) (ON) (ON)	2-1 5-4	OPEN	2-3 5-6	DPDT

For 3 Throw (3-On)

Pole	Model	Up	Center	Down	Connected Terminals & Schematics			External Connection
SP	MLW3020	ON	ON	ON				<p>The SP3T model utilizes a double pole base.</p> <p>External connection must be made during field installation.</p>
With External Connection					2-1	2-4	2-6	
Without External Connection					2-1 5-4	2-3 5-4	2-3 5-6	

TERMINALS

Switch Terminals.

Center terminal is .020" (0.5mm) longer

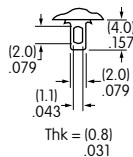

Lamp Terminals

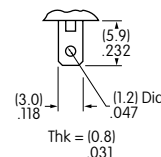

LAMP CODES & SPECIFICATIONS

Electrical specifications are determined at a basic temperature of 25°C. Lamp circuit is independent of switch operation. For dimension drawings of lamps see Accessories & Hardware section. For neon, if the source voltage is greater than rated voltage, a ballast resistor is required. The ballast resistor calculation and more lamp detail are shown in the Supplement.

Incandescent & Neon Lamps for Solid & Design Caps

AT602 Incandescent	AT602N Neon		06	12	18	24	28	N
		V	6V AC	12V AC	18V AC	24V AC	28V AC	110V AC
		I	80mA	50mA	35mA	25mA	22mA	1.5mA
		MSCP	.159	.215	.398	.215	.247	NA
		Endurance Hours	2,000 Average					15,000 Average
		Ambient Temperature Range	-10°C ~ +50°C					-10°C ~ +50°C
Recommended Resistor for Neon: 33K ohms for 110V AC; 100K ohms for 220V AC								
T-1 1/2 Pilot Slide Base			00	No Lamp Code 00 indicates that no lamp is used.				

Toggles
 Rockers
 Pushbuttons
 Illuminated PB
 Programmable
 Keylocks
 Rotaries
 Slides
 Tactiles
 Tilt
 Touch
 Indicators
 Accessories
 Supplement

LED COLOR CODES & SPECIFICATIONS

Single Element LED

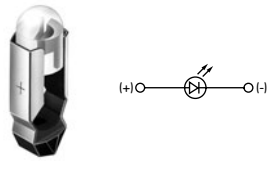
AT622 LED	Resistor value calculation is shown in the Supplement.	Color	C	E	F
			Red	Yellow	Green
 <p>T-1¼ Pilot Slide Base</p>	Forward Peak Current	I_{FM}	30mA	30mA	30mA
	Typical Forward Current	I_F	20mA	20mA	20mA
	Forward Voltage	V_F	1.85V	2.0V	2.1V
	Reverse Peak Voltage	V_{RM}	5V	5V	5V
	Current Reduction Rate Above 25°C	ΔI_F	0.40mA/°C	0.40mA/°C	0.40mA/°C
	Ambient Temperature Range		-10°C ~ +50°C		

CAP TYPES & COLORS

For Incandescent or Neon Lamps

RA AT405 Rocker

- RB RE
- RC RF
- RD RG

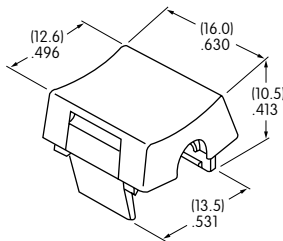

PA AT426 Paddle

- PB PE
- PC PF
- PD PG

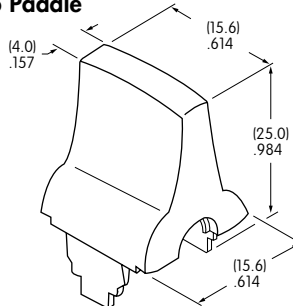

DB AT438 Design Rocker

- DC
- DD
- DF
- DG

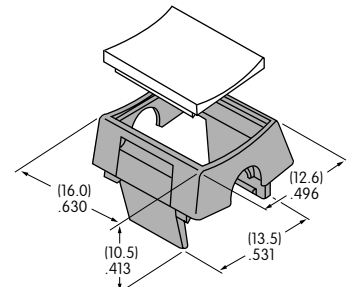

Material: Translucent Polycarbonate Standard Finish: Glossy
Black Rocker/Paddle not for use with lamp

Translucent Colored Filter
Opaque Black Rocker Base

For LED

LB AT4125 LED Rocker

- LC
- LE
- LF

Translucent Colored Diffuser and Opaque Black Rocker Base

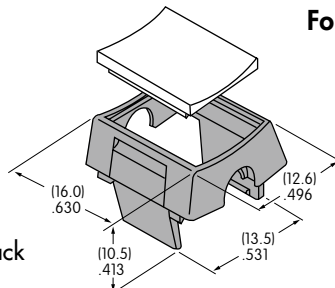

SB AT4127 Sculptured Rocker

- SC
- SE
- SF

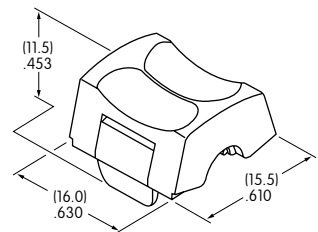

Material: Translucent Polycarbonate Standard Finish: Glossy

Color Codes:

- A** Black
- B** White
- C** Red
- D** Orange
- E** Yellow
- F** Green
- G** Blue

OPTIONAL BEZELS

AT204 Standard Bezel .787" (20.0mm) Wide

- 1A 1E
- 1B 1F
- 1C 1G
- 1D 1H

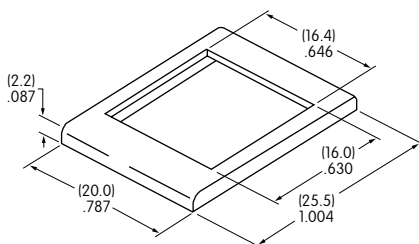

Material: Polycarbonate Standard Finish: Glossy

AT9201 Large Bezel .937" (23.8mm) Wide

- 2A 2E
- 2B 2F
- 2C 2G
- 2D 2H

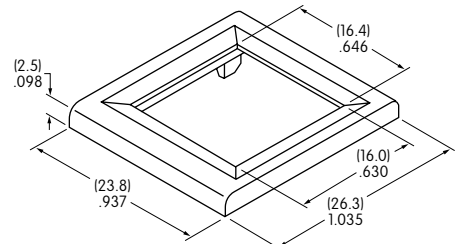

Material: Polycarbonate Standard Finish: Glossy

Toggles
Rockers
Pushbuttons
Illuminated PB
Programmable
Keylocks
Rotaries
Slides
Tactiles
Tilt
Touch
Indicators
Accessories
Supplement

TYPICAL SWITCH DIMENSIONS

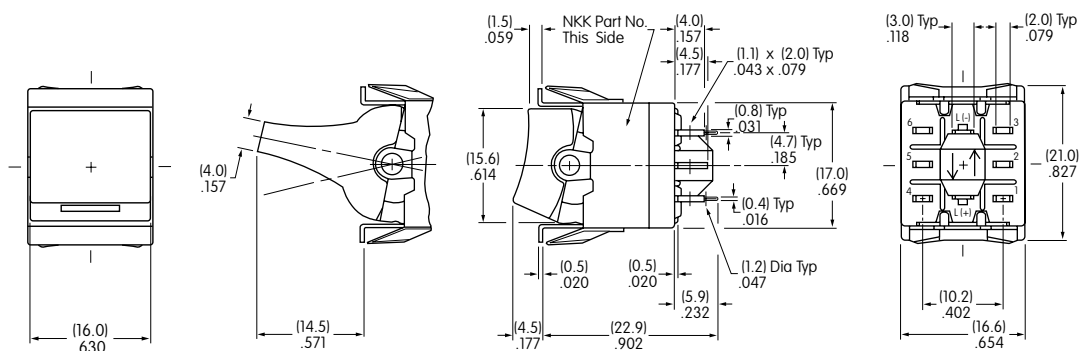

Actuator in UP position

Terminals 4, 5, & 6 are not on single pole models

Without Bezel
Single & Double Pole



MLW3022-12-PC

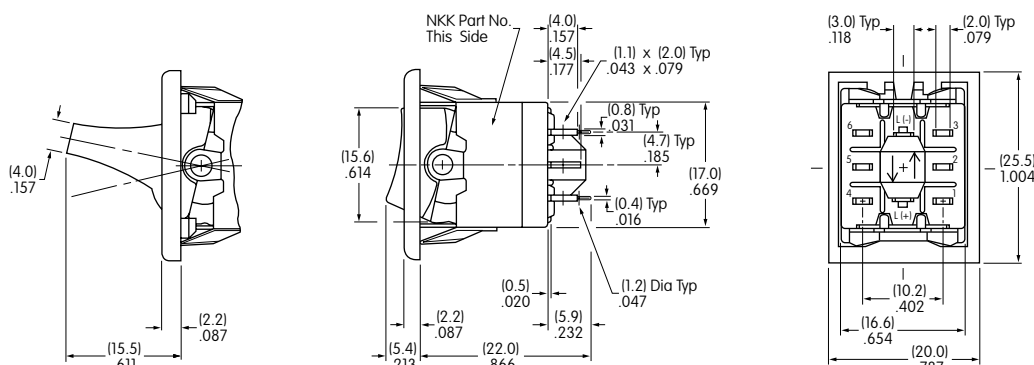

Actuator in UP position

Terminals 4, 5, & 6 are not on single pole models

Standard Bezel
Single & Double Pole



MLW3022-12-RC-1A

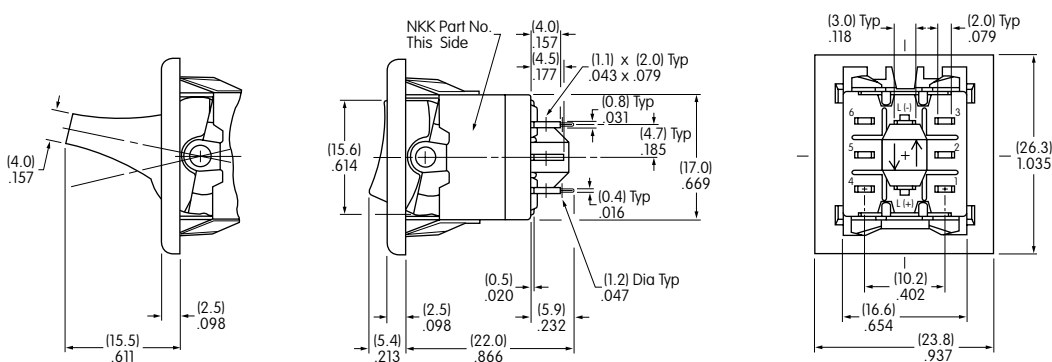

Actuator in UP position

Terminals 4, 5, & 6 are not on single pole models

Large Bezel
Single & Double Pole



MLW3022-12-PC-2A

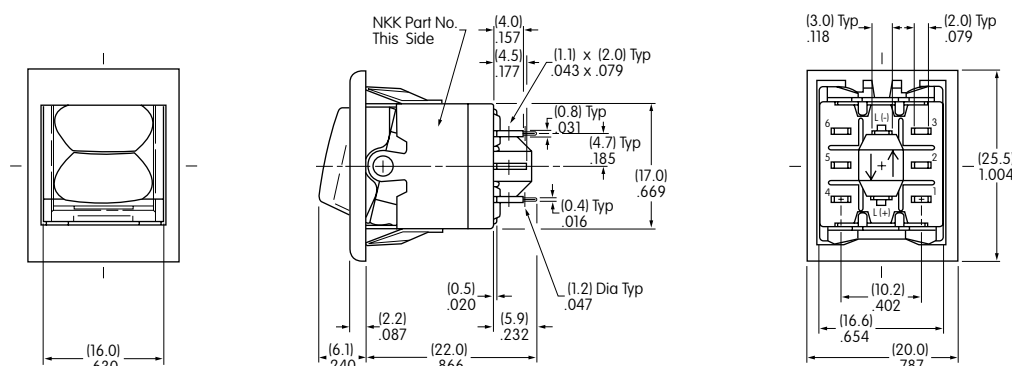

Actuator in UP position

Terminals 4, 5, & 6 are not on single pole models

Sculptured Cap
Single & Double Pole



MLW3022-C-SC-1A

PANEL CUTOUTS & THICKNESSES

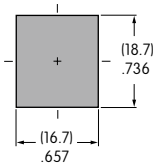

Without Bezel
.039" ~ .157" (1.0mm ~ 4.0mm)

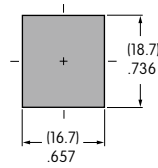

With Standard Bezel AT204
.039" ~ .118" (1.0mm ~ 3.0mm)

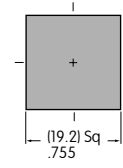

With Large Bezel AT9201
.039" ~ .118" (1.0mm ~ 3.0mm)

INSTALLATION & MAINTENANCE

Lamps and LEDs can be changed without removing the switch from the panel. The lamp extractor AT107 assists in removing lamps and LEDs.

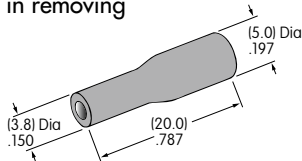

AT107
Lamp Extractor

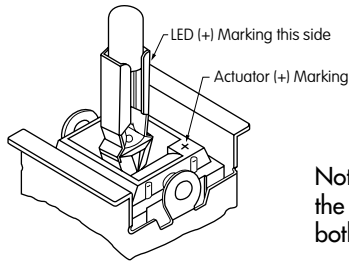

Note: When changing LEDs, match the positive polarity markings on both lamp base and actuator block.

LEGENDS

NKK Switches can provide custom legends for caps. Contact factory for more information.

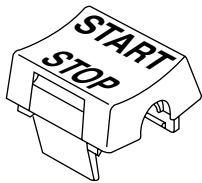

Recommended Print Method:
Pad Print
Epoxy based ink is recommended

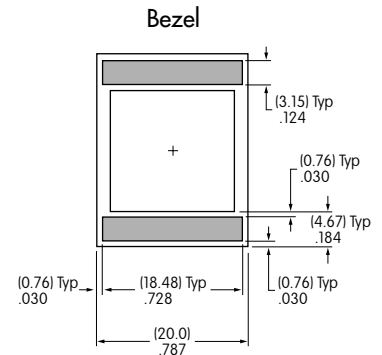
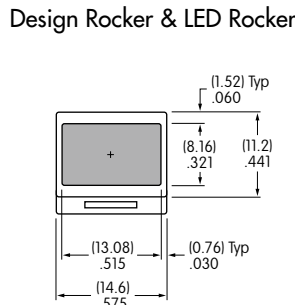
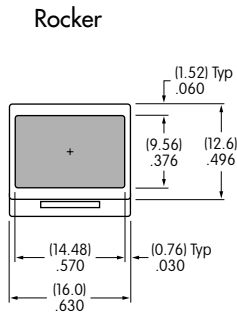

Shaded areas are printable areas.

General Specifications

Toggles

Rockers

Pushbuttons

Illuminated PB

Programmable

Keylocks

Rotaries

Slides

Tactiles

Tilt

Touch

Indicators

Accessories

Supplement

B Electrical Capacity

Resistive Load:	10A @ 125V AC or 6A @ 250V AC
Motor Load:	400W @ 125V AC
Lamp Load:	2A @ 125V AC for On-Off-On circuit & 3A @ 125V AC for other circuits

Other Ratings

Contact Resistance:	10 milliohms maximum
Insulation Resistance:	1,000 megohms minimum @ 500V DC
Dielectric Strength:	2,000V AC minimum between contacts for 1 minute minimum; 4,000V AC minimum between contacts & case for 1 minute minimum
Mechanical Life:	50,000 operations minimum
Electrical Life:	25,000 operations minimum
Angle of Throw:	25°

Materials & Finishes

Frame:	Stainless steel
Case/Base:	Diallyl phthalate resin (UL94V-0)
Movable Contacts:	Silver alloy with silver plating
Stationary Contacts:	Pure silver with silver plating
Terminals:	Copper with silver plating

Environmental Data

Operating Temp Range:	-10°C through +85°C (+14°F through +185°F)
Humidity:	90 ~ 95% humidity for 96 hours @ 40°C (104°F)
Vibration:	10 ~ 55Hz with peak-to-peak amplitude of 1.5mm traversing the frequency range & returning in 1 minute; 3 right angled directions for 2 hours
Shock:	50G (490m/s ²) acceleration (tested in 6 right angled directions, with 5 shocks in each direction)

Installation

Soldering Time & Temp:	Wave Soldering (Straight PC): See Profile A in Supplement section. Manual Soldering: See Profile A in Supplement section.
Cleaning:	These devices are not process sealed. Hand clean locally using alcohol based solution.

Standards & Certifications

Flammability Standards:	UL94V-0 rated case/base
UL:	File No. E44145 - Recognized only when ordered with marking on switch. Add "/U" before dash in part number to order UL recognized switch. Add "/CUL" before dash in part number to order cULus recognized switch. All models recognized at 10A @ 125V AC & 6A @ 250V AC.
CSA:	File No. 023535_0_000 - Certified only when ordered with marking on switch. Add "/C" before dash in part number to order CSA certified switch. All models certified at 10A @ 125V AC & 6A @ 250V AC.
VDE:	License No. 119174 All models approved at 10A @ 125V AC & 6A @ 250V AC. Marking on switch is standard. All models meet EN 61058-1 standard.

Distinctive Characteristics

Meets EN 61058-1 standard.

Contacts of special silver alloy resist arcing and guarantee stable electrical contact and long life.

Stainless steel frame resists corrosion and increases environmental safety.

High insulating barriers increase isolation of circuits in double pole devices and provide added protection to contact points.

Case/base of heat resistant resin meets UL94V-0 flammability standard.

Prominent external insulating barriers increase insulation resistance and dielectric strength.

Clinching of the frame to the case well above the base and terminals provides 4,000V dielectric strength.

Epoxy sealed terminals prevent entry of flux, solvents, and other contaminants.

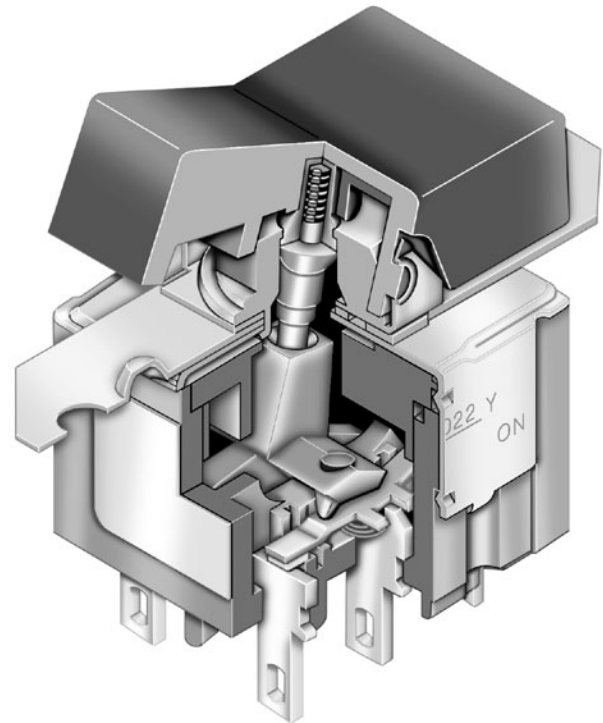

Actual Size

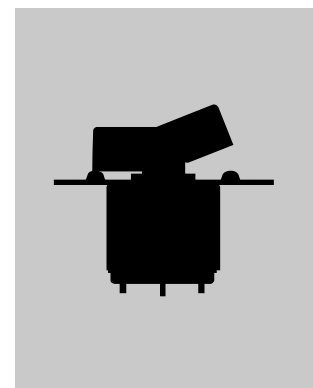

Supplement	Accessories	Indicators	Touch	Tilt	Tactiles	Slides	Rotaries	Keylocks	Programmable	Illuminated PB	Pushbuttons	Rockers	Toggle
------------	-------------	------------	-------	------	----------	--------	----------	----------	--------------	----------------	-------------	---------	--------

TYPICAL SWITCH ORDERING EXAMPLE

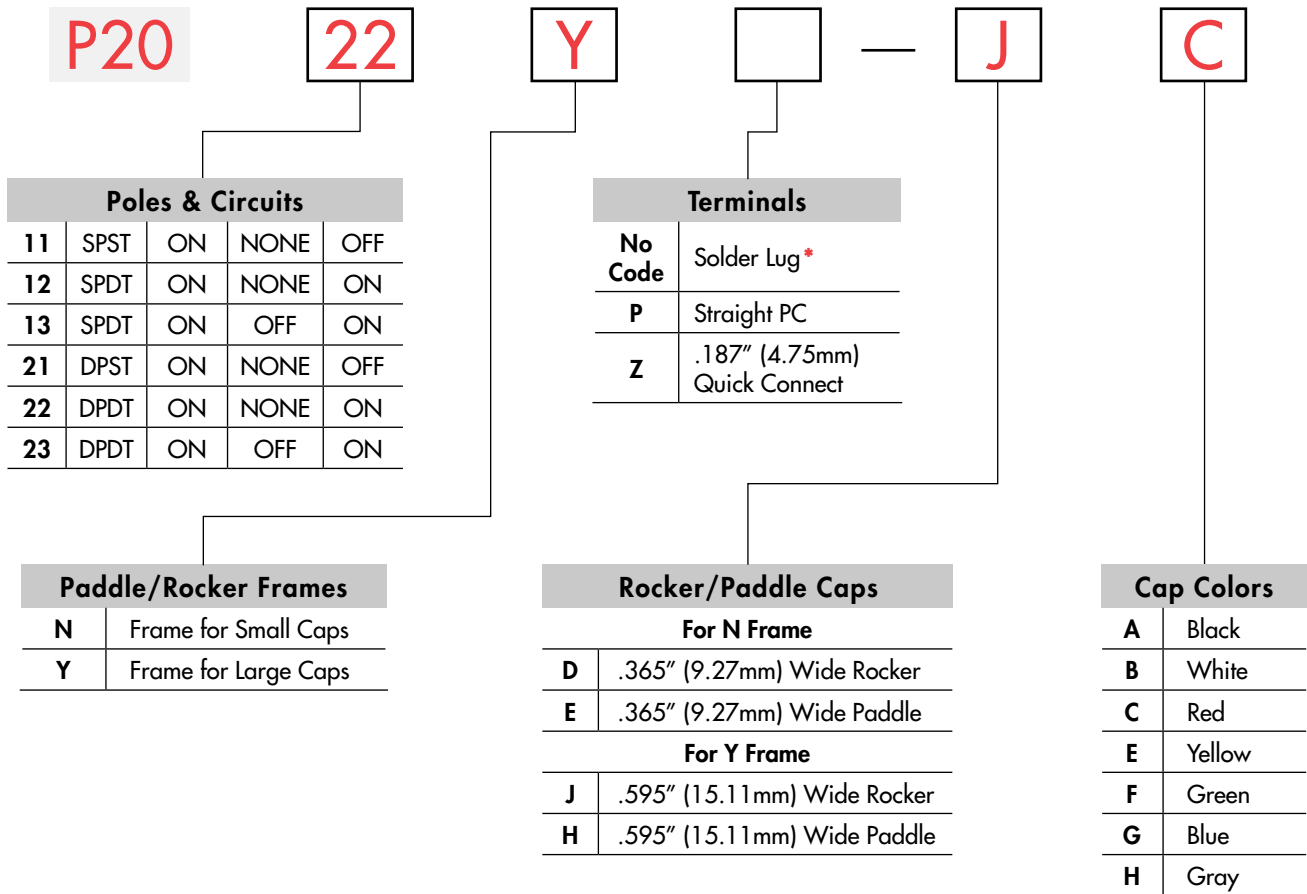

IMPORTANT:



VDE is marked on all models. Switches are supplied without UL, cULus & CSA marking unless specified. **UL, cULus & CSA recognized only when ordered with marking on the switch.** Specific models, ratings, & ordering instructions are noted on General Specifications page.

* Wire harness & cable assemblies offered only in Americas

DESCRIPTION FOR TYPICAL ORDERING EXAMPLE

P2022Y-JC

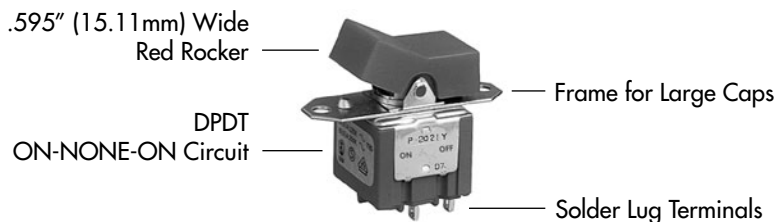

POLES & CIRCUITS

		Rocker Position			Connected Terminals			Throw & Schematics
Pole	Model	Down	Center	Up	Down	Center	Up	Note: Terminal numbers are on the switch.
SP	P2011	ON	NONE	OFF	1-1b	OPEN	OPEN	SPST
SP	P2012 P2013	ON ON	NONE OFF	ON ON	1-1b	OPEN	1-1a	SPDT
DP	P2021	ON	NONE	OFF	1-1b 2-2b	OPEN	OPEN	DPST
DP	P2022 P2023	ON ON	NONE OFF	ON ON	1-1b 2-2b	OPEN	1-1a 2-2a	DPDT

ROCKER/PADDLE FRAMES

N Frame for Small Actuator

Y Frame for Large Actuator

Using AT4148 & AT4149

Using AT4156 & AT4157

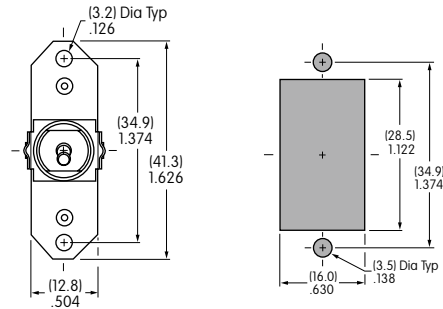
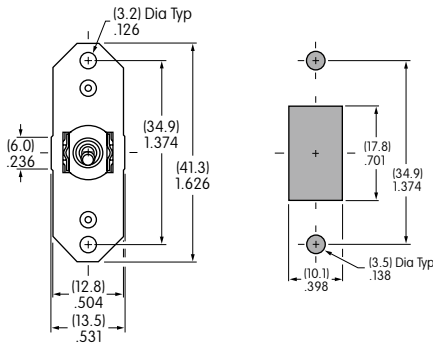

Maximum Panel Thickness: .126" (3.2mm)

Maximum Panel Thickness: .126" (3.2mm)

TERMINALS

No Code Solder Lug

Z .187" (4.75mm) Quick Connect

P Straight PC

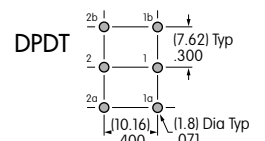
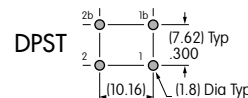
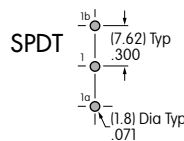
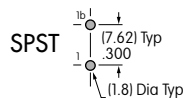
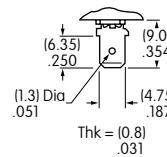
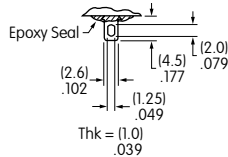
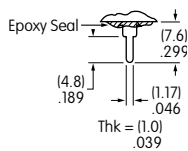

ROCKER/PADDLE CAPS

For N Frame

D AT4148
.365" (9.27mm) Wide Rocker

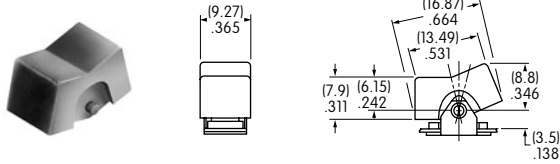

E AT4149
.365" (9.27mm) Wide Paddle

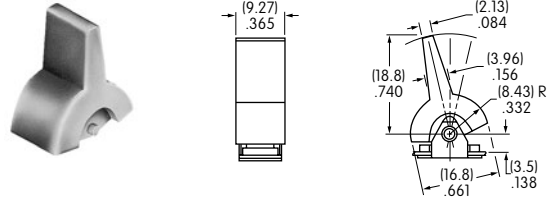

For Y Frame

J AT4156
.595" (15.11mm) Wide Rocker

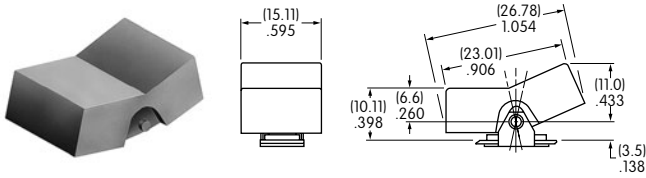

H AT4157
.595" (15.11mm) Wide Paddle

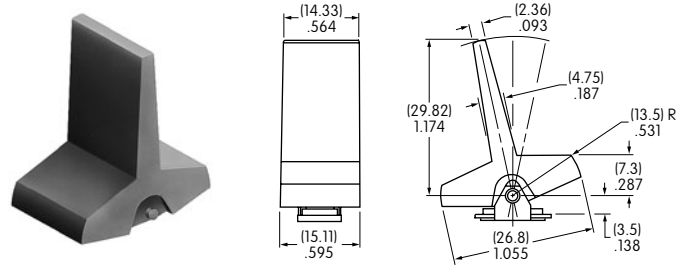

Cap Colors Available:

A Black **B** White **C** Red **E** Yellow **F** Green **G** Blue **H** Gray

Material: Polyamide Finish: Matte

TYPICAL SWITCH DIMENSIONS

N Frame

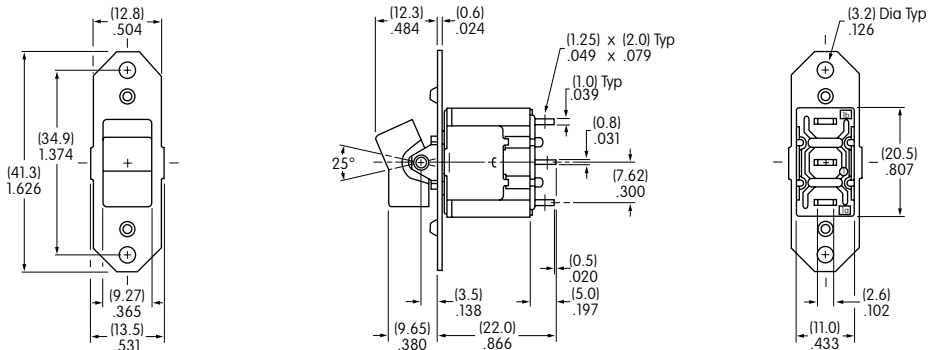

P2012N-DC

P2011 & P2021 models do not have terminals 1a & 2a.

Y Frame

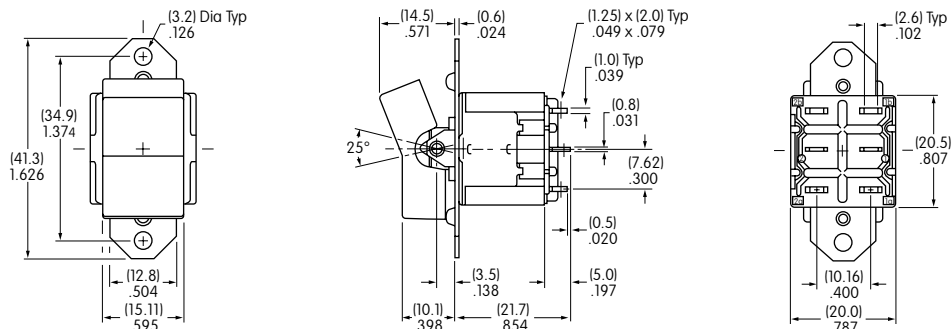

P2022Y-JC

P2011 & P2021 models do not have terminals 1a & 2a.

GENERAL SPECIFICATIONS FOR SW3000s

Toggles

Rockers

Pushbuttons

Illuminated PB

Programmable

Keylocks

Rotaries

Slides

Tactiles

Tilt

Touch

Indicators

Accessories

Supplement

B Electrical Capacity (Resistive & Inductive Load)**Power Level:** Shown in the following tables**Other Ratings**

Contact Resistance: 10 milliohms maximum
Insulation Resistance: 1,000 megohms minimum @ 500V DC
Dielectric Strength: 2,000V AC minimum for 1 minute minimum
Mechanical Life: 30,000 operations minimum
Electrical Life: 10,000 operations minimum
Angle of Throw (α): Shown on drawings or following tables

Materials & Finishes

Rocker: Urea resin; all rockers are white.
Mounting Frame: Steel with chromate plating over zinc plating
Case Cover/Insulator: Phenolic resin
Case: Melamine phenol
Movable Contactor Plate: Copper with silver plating
Movable & Stationary Contacts: Silver alloy plus copper with silver plating
Terminals: Copper with tin plating

Environmental Data

Operating Temp Range: -10°C through +70°C (+14°F through +158°F)
Sealing: Dustproof cover of silicone rubber on SW3006A, SW3007A, & SW3008A

Installation

Maximum Panel Thickness: Shown with following drawings
Soldering Time & Temperature: Manual Soldering: See Profile A in Supplement section.

Standards & Certifications

- UL: File No. E44145 - Recognized only when ordered with marking on switch.**
 Add "/U" or "/CUL" to end of part number to order UL recognized switch.
 UL or cULus recognition designated beside part numbers on following pages.
 See Supplement section to find UL or cULus rating details.
- CSA: File No. 023535_0_000 - Certified only when ordered with marking on switch.**
 Add "/C" to end of part number to order CSA certified switch.
 CSA certification designated beside part numbers on following pages.
 See Supplement section to find CSA rating details.
- VDE: License No. 119189 - Approved only when ordered with marking on switch.**
 Add "/V" to end of part number to order VDE approved switch.
 SW3006A at 20A @ 125V AC & 10A @ 250V AC

SINGLE POLE WITH SOLDER LUG *

* UL & CSA recognized only when ordered with marking on switch (see General Specs)		Rocker Position/Connected Terminals						Electrical Capacity					
Model	* Approvals		Pole	Down		Center	Up		Resistive		Inductive	$\alpha =$ Angle of Throw	
									AC 125V	AC 250V	DC 30V		AC 125V PF 0.6
SW3001A	✓	✓	SPST	ON	1-3	NONE	OFF	—	15A	6A	15A	10A	24°
SW3002A	✓	✓	SPDT	ON	2-3	NONE	ON	2-1	15A	6A	15A	10A	24°
SW3003A	✓	✓	SPDT	ON	2-3	OFF	ON	2-1	15A	6A	15A	10A	28°

Throw & Schematics: SPST INTERNAL CONNECTION Note: Terminal numbers are actually on the switch.

* Wire harness & cable assemblies offered only in Americas.

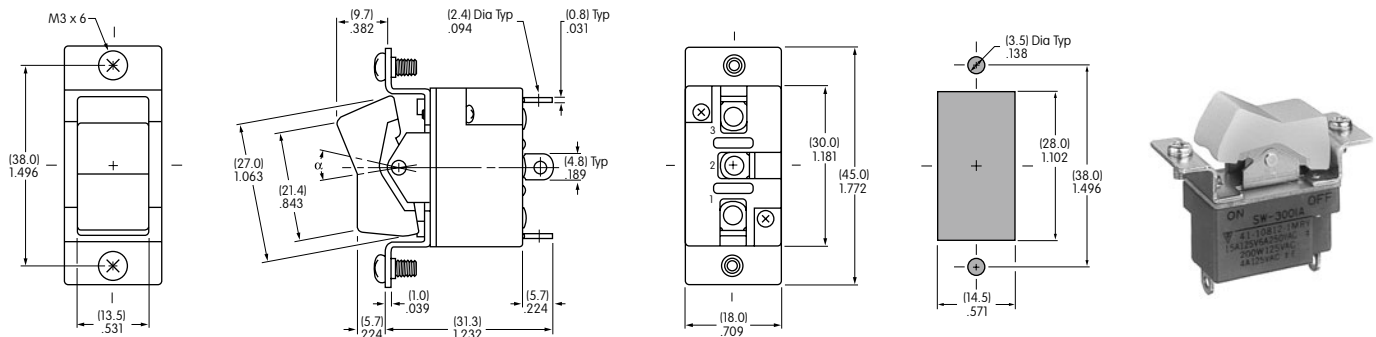

Maximum Effective Panel Thickness:

SW3001A does not have terminal 2. .197" (5.0mm) for SW3001A & SW3002A models; .177" (4.5mm) for SW3003A models **SW3001A**

DOUBLE POLE WITH SOLDER LUG *

* UL, cULus & CSA recognized only when ordered with marking on switch (see General Specs)		Rocker Position/Connected Terminals () = Momentary						Electrical Capacity						
Model	* Approvals			Down		Center	Up		Resistive		Inductive	$\alpha =$ Angle of Throw		
									AC 125V	AC 250V	DC 30V		AC 125V PF 0.6	
SW3006A	✓	✓	✓	DPDT	ON	2-3 5-6	NONE	ON	2-1 5-4	20A	10A	20A	10A	24°
SW3007A	—	—	✓	DPDT	ON	2-3 5-6	OFF	ON	2-1 5-4	15A	6A	15A	10A	28°
SW3008A	—	—	—	DPDT	(ON)	2-3 5-6	OFF	(ON)	2-1 5-4	15A	6A	15A	10A	24°

Throw & Schematic: DPDT Note: Terminal numbers are actually on the switch.

* Wire harness & cable assemblies offered only in Americas.

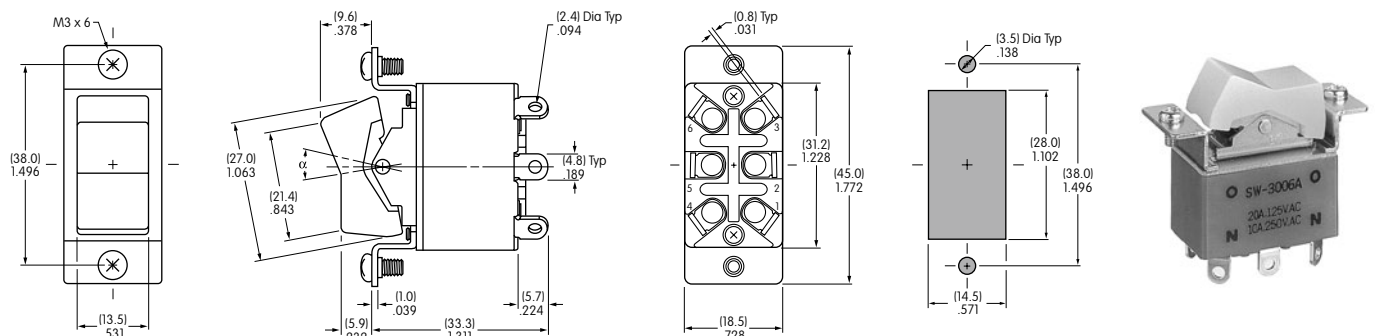

Maximum Effective Panel Thickness:

.197" (5.0mm) for SW3006A & SW3008A models; .177" (4.5mm) for SW3007A models **SW3006A**

GENERAL SPECIFICATIONS FOR SW3800s

B Electrical Capacity (Resistive & Inductive Load)

Power Level: Shown in the following tables
 Note: See Supplement section for details of design for inductive DC loads.

Other Ratings

Contact Resistance: 10 milliohms maximum
Insulation Resistance: 1,000 megohms minimum @ 500V DC
Dielectric Strength: 2,000V AC minimum for 1 minute minimum
Mechanical Life: 50,000 operations minimum
Electrical Life: 25,000 operations minimum
Angle of Throw: Shown on following drawings
Nominal Operating Force: 1,800 grams for SW3822
 2,200 grams for SW3823 Off to On
 800 grams for SW3823 On to Off

Materials & Finishes

Rocker: Urea resin; all rockers are white.
Mounting Frame: Steel with chromate plating over zinc plating
Case Cover/Insulator: Phenolic resin
Case: Melamine phenol
Movable Contacts: Copper with silver plating
Stationary Contacts: Silver alloy plus copper with silver plating
Terminals: Brass (terminal screws of brass with nickel plating)

Environmental Data

Operating Temp Range: -10°C through +70°C (+14°F through +158°F)

Standards & Certifications

UL: **File No. E44145 - Recognized only when ordered with marking on switch.**
 Add "/U" or "/CUL" to end of part number to order UL recognized switch.
 UL or cULus recognition designated beside part numbers on following pages.
 See Supplement section to find UL or cULus rating details.

CSA: **File No. 023535_0_000 - Certified only when ordered with marking on switch.**
 Add "/C" to end of part number to order CSA certified switch.
 CSA certification designated beside part numbers on following pages.
 See Supplement section to find CSA rating details.

Wiring for DC400V 10A

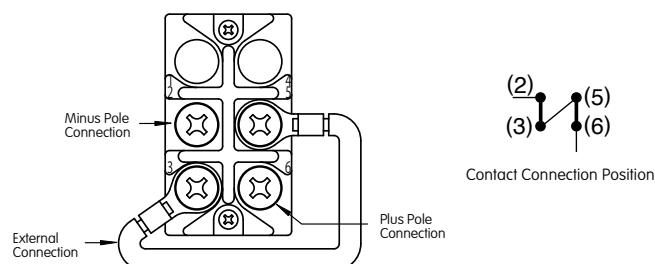

DOUBLE POLE WITH SCREW LUG

Model	*Approvals UL cULus CSA	Pole	Rocker Position/Connected Terminals						Electrical Capacity							
			Down		Center	Up		Resistive				Inductive				
			AC 125V	AC 250V	DC 30V	DC 48V	DC 125V	DC 250V	DC 400V	AC 125V PF 0.6	AC 250V PF 0.6					
SW3821	✓	✓	✓	DPST	ON 2-3 5-6	NONE	OFF —	30A	30A	30A	—	1A	—	—	30A	15A
SW3822	✓	✓	✓	DPDT	ON 2-3 5-6	NONE	ON 2-1 5-4	30A	30A	30A	—	1A	—	—	30A	15A
SW3823	✓	✓	✓	DPDT	ON 2-3 5-6	OFF	ON 2-1 5-4	30A	30A	30A	—	1A	—	—	30A	15A
SW3821D	✓	✓	✓	DPST	ON 2-3 5-6	NONE	OFF —	—	—	30A	30A	20A	15A	4A (10A)	—	—
SW3822D	✓	✓	✓	DPDT	ON 2-3 5-6	NONE	ON 2-1 5-4	—	—	30A	30A	20A	15A	4A	—	—
SW3823D	✓	✓	✓	DPDT	ON 2-3 5-6	OFF	ON 2-1 5-4	—	—	30A	30A	15A	—	—	—	—

Throw & Schematics: DPST DPDT

Note: Terminal numbers are actually on the switch.

* UL/CUL & CSA for the following ratings: UL/CUL: 30A @ 30V DC, 15A @ 125V DC; CSA: 30A @ 30V DC, 15A @ 125V DC

* UL, cULus & CSA recognized only when ordered with marking on switch (see General Specs)

() capacity is due to series wiring, see General Specifications page.

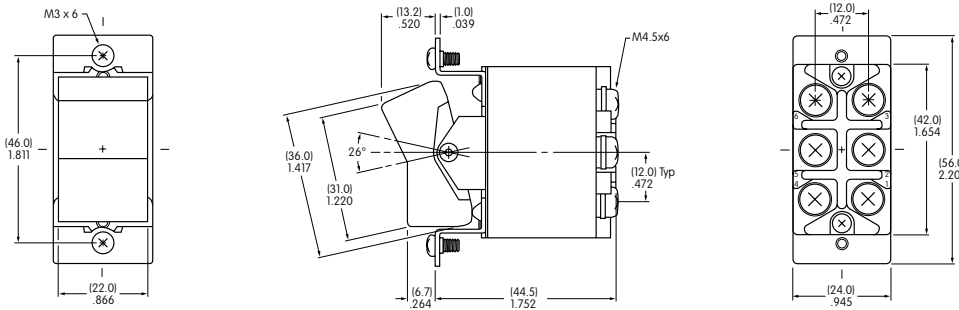

SW3821 & SW3821D do not have terminals 1 & 4.

Maximum Effective Panel Thickness .177" (4.5mm). Panel cutout shown below.

SW3822

THREE POLE WITH SCREW LUG

Model	*Approvals UL cULus CSA	Pole	Rocker Position/Connected Terminals						Electrical Capacity					
			Down		Center	Up		Resistive				Inductive		
			AC 125V	AC 250V	DC 30V	DC 48V	DC 125V	DC 250V	DC 400V	AC 125V PF 0.6	AC 250V PF 0.6			
SW3831	✓	✓	✓	3PST	ON 2-3 5-6 8-9	NONE	OFF —	30A	30A	30A	1A	30A	15A	
SW3832	✓	✓	✓	3PDT	ON 2-3 5-6 8-9	NONE	ON 2-1 5-4 8-7	30A	30A	30A	1A	30A	15A	
SW3833	✓	✓	✓	3PDT	ON 2-3 5-6 8-9	OFF	ON 2-1 5-4 8-7	30A	30A	30A	1A	30A	15A	
SW3831D	✓	✓	✓	3PST	ON 2-3 5-6 8-9	NONE	OFF —	—	—	30A	15A	—	—	
SW3832D	✓	✓	✓	3PDT	ON 2-3 5-6 8-9	NONE	ON 2-1 5-4 8-7	—	—	30A	15A	—	—	
SW3833D	✓	✓	✓	3PDT	ON 2-3 5-6 8-9	OFF	ON 2-1 5-4 8-7	—	—	30A	15A	—	—	

Throw & Schematics: 3PST 3PDT

Note: Terminal numbers are actually on the switch.

* UL/CUL & CSA for the following ratings: UL/CUL: 30A @ 30V DC, 15A @ 125V DC; CSA: 30A @ 30V DC, 15A @ 125V DC

* UL, cULus & CSA recognized only when ordered with marking on switch (see General Specs)

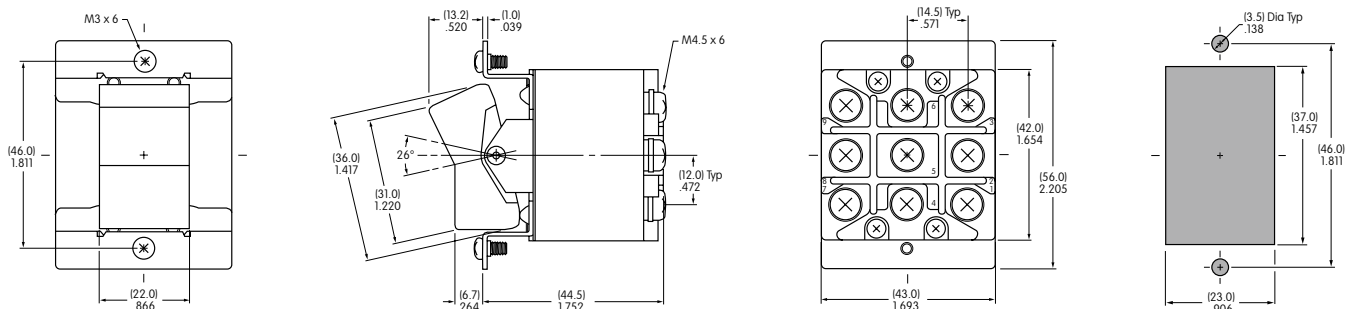

SW3831 & SW3831D do not have terminals 1, 4 & 7.

Maximum Effective Panel Thickness .177" (4.5mm)

Rockers
Pushbuttons
Illuminated PB
Programmable
Keylocks
Rotaries
Slides
Tactiles
Tilt
Touch
Indicators
Accessories
Supplement

General Specifications

Electrical Capacity (Resistive Load)

Power Level: 15A @ 125/250V AC or 15A @ 30V DC

Other Ratings

Contact Resistance: 10 milliohms maximum for solder lug, screw & quick connect terminal models
30 milliohms maximum for wire lead terminal models

Insulation Resistance: 200 megohms minimum @ 500V DC

Dielectric Strength: 1,250V AC minimum between contacts for 1 minute minimum
3,750V AC minimum between contacts & case for 1 minute minimum

Mechanical Life: 30,000 operations minimum

Electrical Life: 15,000 operations minimum for circuit 11 and 12 models
10,000 operations minimum for circuit 13, 15, 18, 19 models

Angle of Throw: 24°

Materials & Finishes

Rocker: Phenylene oxide

Outer Housing: Polyamide (UL94V-0)

Inner Case: Melamine (UL94V-0)

Cover for Wire Lead Models: Glass fiber reinforced polyamide (UL94V-0)

Flange Gasket: Nitrile butadiene rubber

Movable Contactor: Copper with silver plating

Movable Contacts: Silver alloy plus copper with silver plating

Stationary Contacts: Silver alloy plus copper with silver plating

Terminals: Copper with tin plating for solder lug & wire lead

Brass with silver plating for screw lug

Brass with tin plating for quick connect

Wire Lead Covers: Heat resistant polyvinyl chloride (Leads are AWG 14)

Environmental Data

Operating Temp Range: -25°C through +85°C (-13°F through +185°F)

Humidity: 90 ~ 95% humidity for 96 hours @ 40°C (104°F)

Vibration: 10 ~ 55Hz with peak-to-peak amplitude of 1.5mm traversing the frequency range & returning in 1 minute; 3 right angled directions for 2 hours

Shock: 50G (490m/s²) acceleration (tested in 6 right angled directions, with 5 shocks in each direction)

Front Panel Seal: IP67 of IEC60529, dust tight & water protected during temporary immersion for all models

Behind Panel Seal: IP60 of IEC60529, dust tight but not water protected for solder lug, screw & quick connect models
IP67 of IEC60529, dust tight & water protected during temporary immersion for wire lead models

Installation

Soldering Time & Temp: Manual Soldering: See Profile A in Supplement section.

Cleaning: Hand clean locally using alcohol based solution.

Standards & Certifications

Flammability Standards: UL94V-0 outer housing, inner case, & outer cover on wire lead models

UL: **File No. E44145 - Recognized only when ordered with marking on switch.**
Add "/U" or "/CUL" to end of part number to order UL recognized switch.
Solder & screw lug models recognized at 15A @ 125/250V AC & 15A @ 30V DC.

VDE: **License No. 126501 - Approved only when ordered with marking on switch.**
Add "/V" to end of part number to order VDE approved switch.
All models approved at 15A @ 250V AC (pending for quick connect).

EN: **No. 61058-1**
WR11 & WR12 models meet European Norm for 3mm contact gap to prevent contact welds.

Wiring Material Standards: UL AWM 1015 Recognized at Flammability VW-1.
Temperature Range -20°C ~ +105°C; Maximum Load 600V; AWG 14.
CSA TEW 105 Certified at Temperature Range -20°C ~ +105°C; Maximum Load 600V.

Distinctive Characteristics

Single unit construction of the flange and outer housing gives added protection from environmental elements.

Specially designed contact mechanism for breaking light welds.

Minimal contact bounce achieved with specially designed interlocked switching mechanism.

Heat resistant resin used for outer housing, inner case, and cover on wire lead models meets UL94V-0 flammability standard and provides high arc and tracking resistance.

Available with solder lug, screw, quick connect, and wire lead terminations.

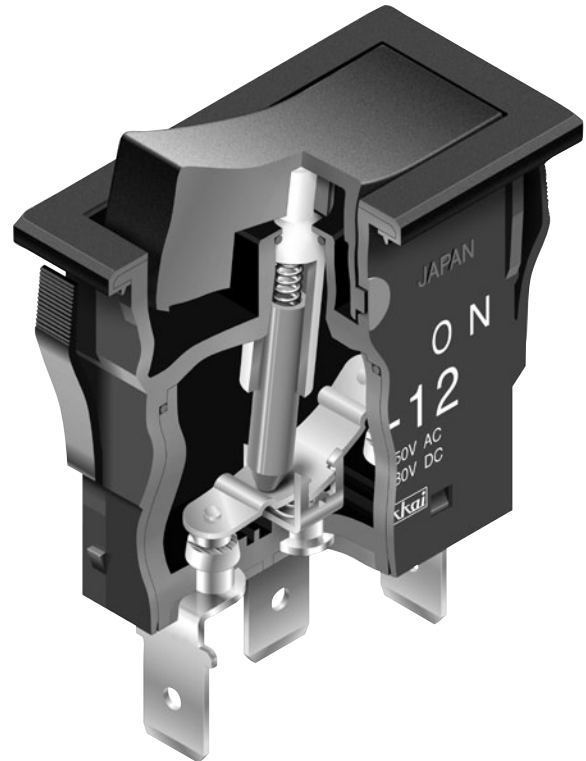

Sealed Construction Meets IP60 & IP67 Standards

Solder lug, screw, and quick connect terminal models meet IP67 of IEC60529 Standards at front panel (dust tight and water protected for temporary immersion, patent pending). Behind panel standard is IP60 (dust tight but not water protected).

Wire lead models conform fully to IP67 of IEC60529 Standards at front and behind panel (dust tight and water protected for temporary immersion). Switch base is epoxy sealed and covered by an outer case for further protection from dust and water. (Switches cannot be operated under water. Contact factory for further details regarding operating environment.)

Actual Size

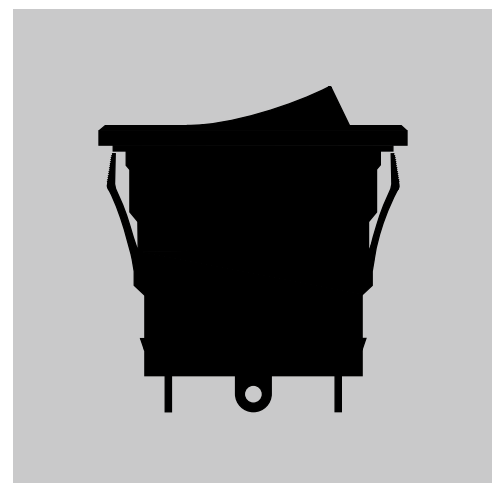

- Supplement
- Accessories
- Indicators
- Touch
- Tilt
- Tactiles
- Slides
- Rotaries
- Keylocks
- Programmable
- Illuminated PB
- Pushbuttons
- B** Rockers
- Toggle

TYPICAL SWITCH ORDERING EXAMPLE

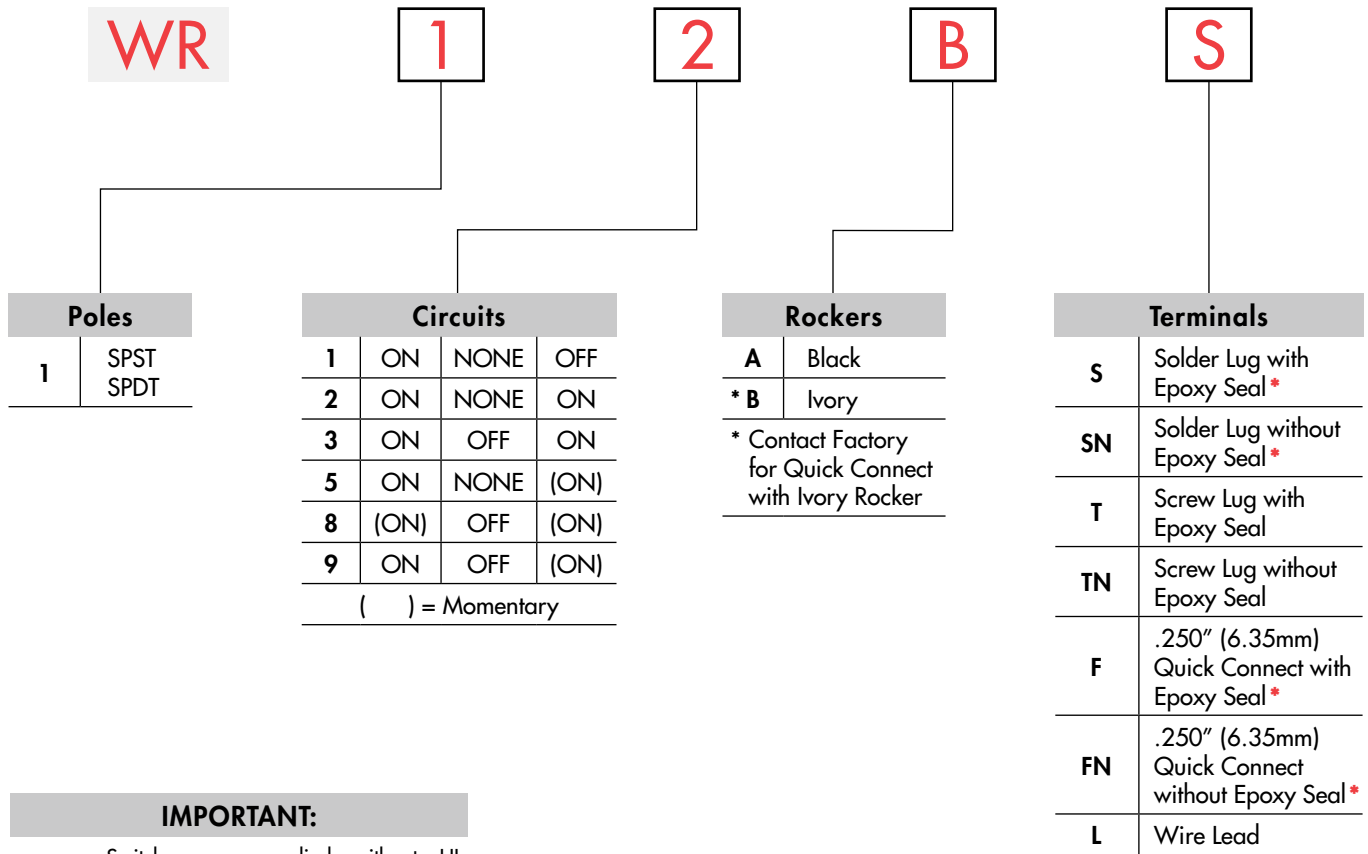

IMPORTANT:



Switches are supplied without UL, cULus & VDE marking unless specified. **UL, cULus & VDE recognized only when ordered with marking on the switch.** Specific models, ratings, & ordering instructions are noted on General Specifications page.

* Wire harness & cable assemblies offered only in Americas

DESCRIPTION FOR TYPICAL ORDERING EXAMPLE

WR12BS



POLES & CIRCUITS

Pole	Model	Rocker Position () = Momentary			Connected Terminals			Throw & Schematics
		Down	Center	Up	Down	Center	Up	
SP	WR11	ON	NONE	OFF	1a-1b	OPEN	OPEN	SPST
SP	WR12 WR13 WR15 WR18 WR19	ON ON ON (ON) ON	NONE OFF NONE OFF OFF	ON ON (ON) (ON) (ON)	1-1b	OPEN	1-1a	SPDT

Toggles
 Rockers
 Pushbuttons
 Illuminated PB
 Programmable
 Keylocks
 Rotaries
 Slides
 Tactiles
 Tilt
 Touch
 Indicators
 Accessories
 Supplement

TYPICAL SWITCH DIMENSIONS

Solder Lug Terminals

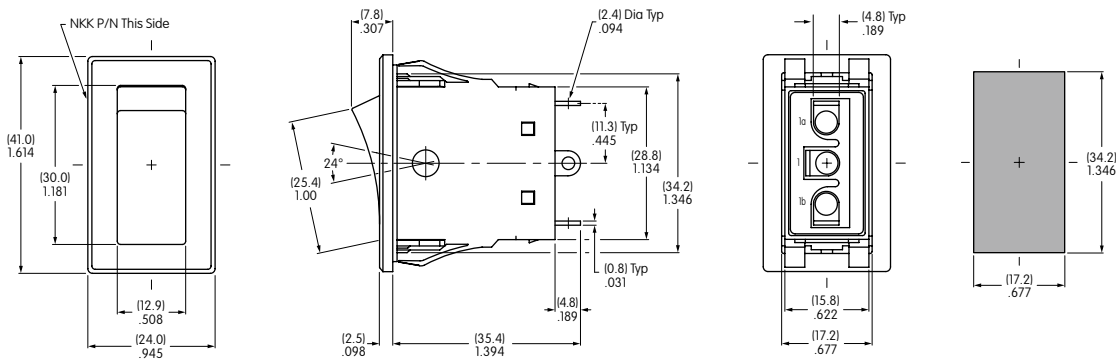

WR11 model does not have terminal 1.

Panel Thickness
.039" ~ .157"
(1.0mm ~ 4.0mm)

WR12AS

Screw Lug Terminals

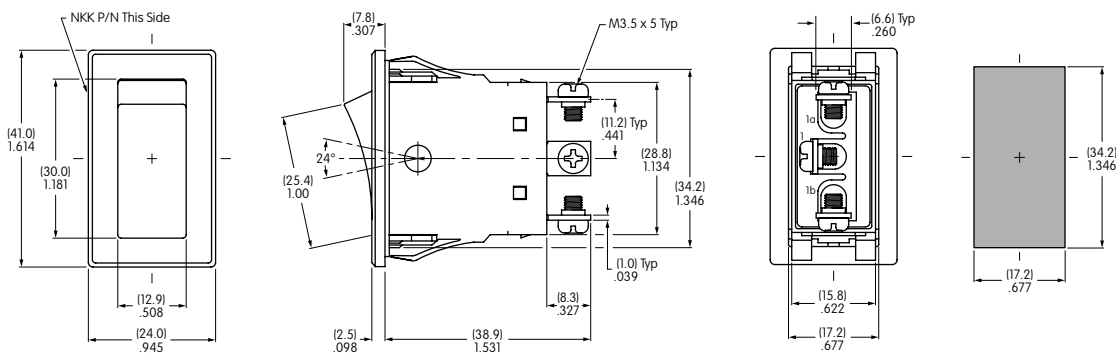

WR11 model does not have terminal 1.

Panel Thickness
.039" ~ .157"
(1.0mm ~ 4.0mm)

WR12AT

TYPICAL SWITCH DIMENSIONS

.250" (6.35mm) Quick Connect Terminals

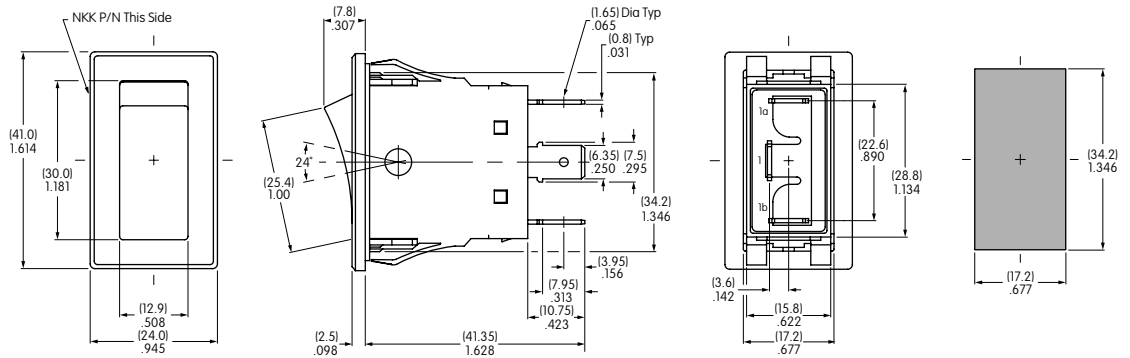

WR13AF

WR11 model does not have terminal 1.

Panel Thickness
.039" ~ .157"
(1.0mm ~ 4.0mm)

Wire Lead Terminals

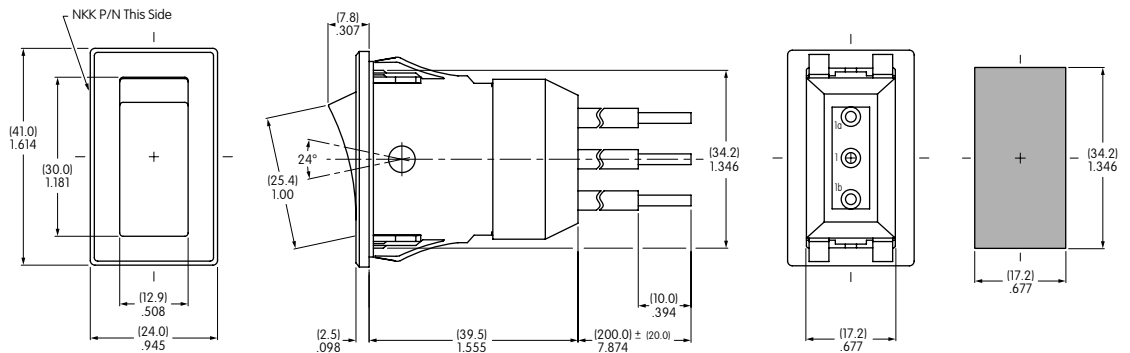

WR15BL

WR11 model does not have terminal 1.

Panel Thickness
.039" ~ .157"
(1.0mm ~ 4.0mm)

STANDARD WIRE COLOR SCHEME

Wire leads are covered with heat resistant vinyl in accordance with UL 1015 and CSA TEW 105 Standards for Appliance Wiring Material (AWM).

Terminal Numbers & Wire Colors			
	1a	1	1b
WR11	Black		White
WR12-19	White	Black	Red